

*Danfoss*

ENGINEERING  
TOMORROW

Selection Guide | iC7-Automation, iC7-Marine, iC7-Hybrid

Need **flexibility** to **create** more  
**competitive systems?**

**Intelligence**  
to empower your  
applications

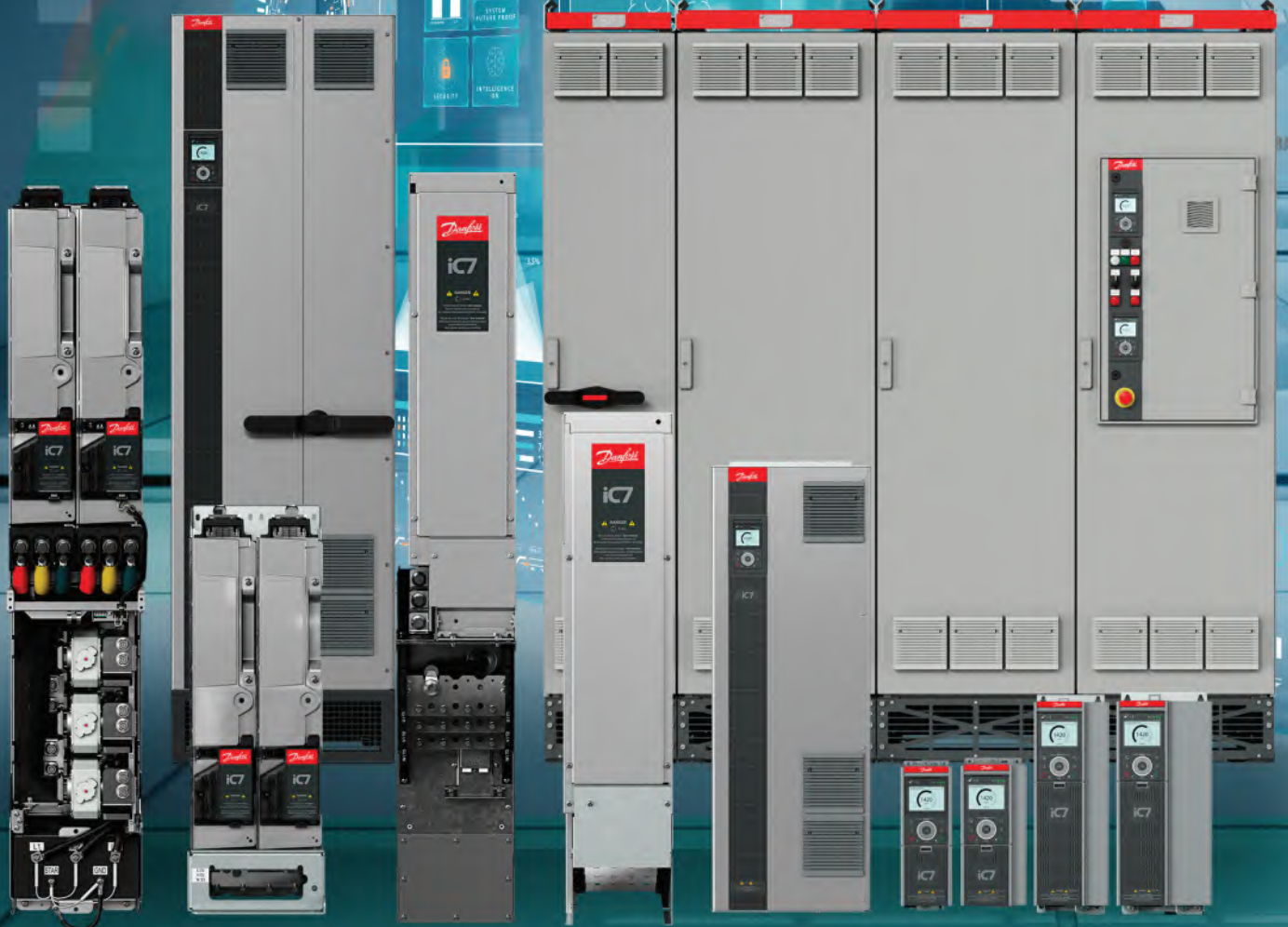



# Contents



 <b>Frequency Converters</b> .....	<b>4</b>
Features and benefits .....	8
Key specifications.....	9
Ratings .....	10
Dimensions .....	13
Model code.....	14



 <b>System Modules</b> .....	<b>16</b>
 <b>Air-cooled System Modules</b> .....	<b>18</b>
Features and benefits.....	20
Key specifications.....	21
<b>Ratings</b>	
Inverter module (INU) .....	22
AFE module .....	26
Dimensions.....	30



 <b>Liquid-cooled System Modules</b> .....	<b>32</b>
Features and benefits.....	34
Key specifications.....	36
<b>Ratings</b>	
Inverter module (INU) .....	39
AFE module .....	43
Grid Converter module .....	47
DC/DC Converter .....	51
Dimensions.....	55

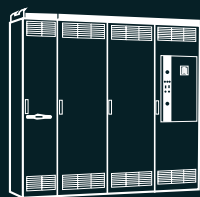

 <b>Enclosed Drives</b> .....	<b>56</b>
Features and benefits .....	60
Key specifications.....	61
Ratings .....	62
Cabinet options.....	63
Dimensions .....	65



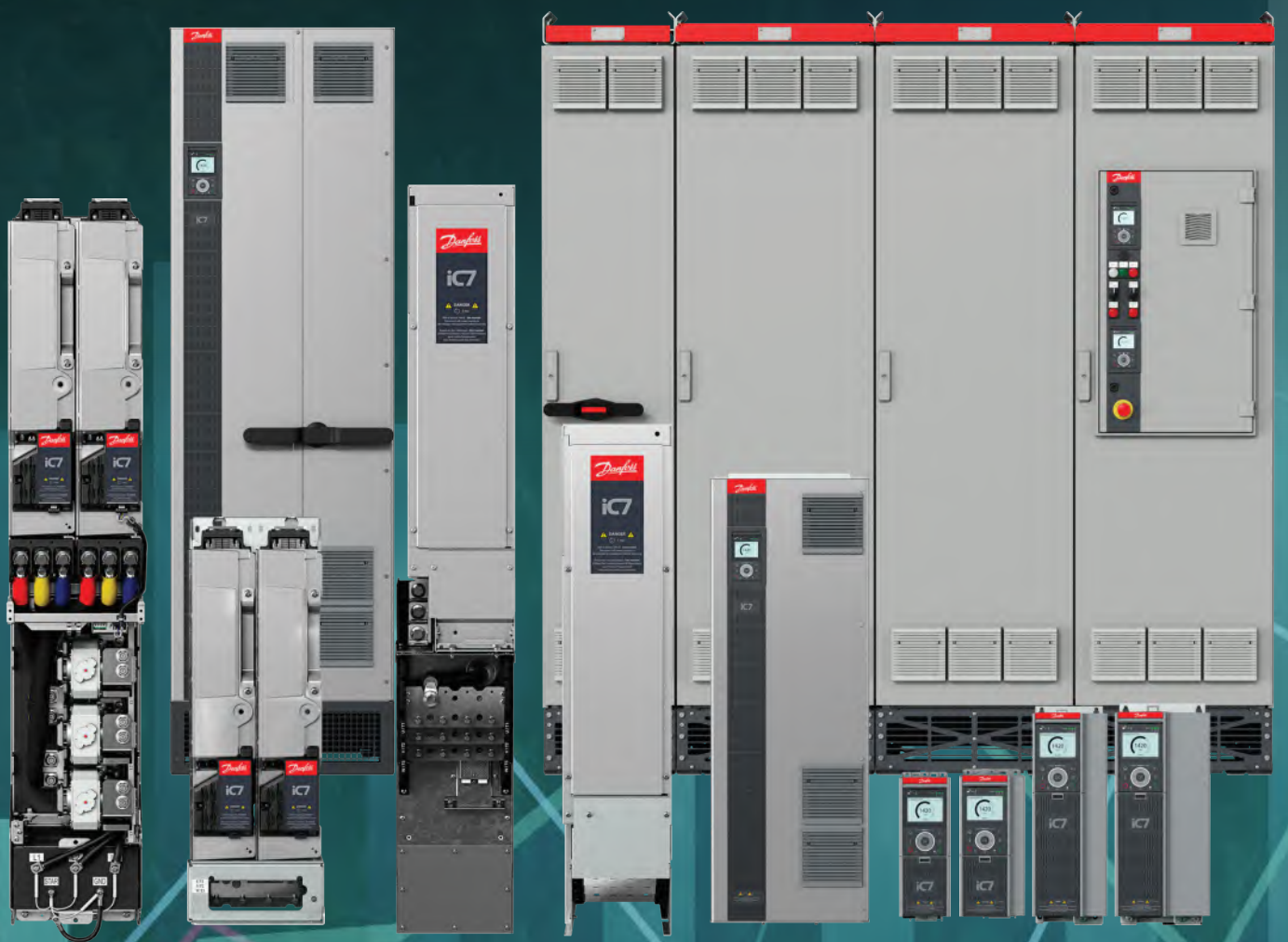

# Frequency Converters

## Need flexibility to create more competitive systems?

The iC7 series of intelligent AC drives puts the power of compactness and integrated intelligence in your hands, so you can boost machine performance in new ways.

With the best heat management available anywhere, this drive delivers high torque performance in a small footprint, so you can get much more power into small spaces.

Integrated intelligence enables the drive to function as your most powerful sensor meaning you can regulate your process highly efficiently, saving money by reducing external devices.

For quick and trouble-free system integration the frequency converter comes with built-in EMC and harmonic filters.

Manage your process data in the cloud or your internal network with world-class stringent security.

You get full data traceability with end-to-end integrated digitized quality

control throughout the drive lifetime from design and testing through to installation and service.

Frequency converters in the iC7 series are optimized for wall-mounted, cabinet-mounted or free-standing installation, and meet requirements for operation at ambient temperatures up to 60°C.

## HIGHLIGHTS

- **Modular and configurable drive**
- **STO SIL3 as standard**
- **Scalable control platform**
- **Powerful hardware-based security including end-to-end encrypted data transfer**
- **Connectivity with multiple fieldbuses**
- **Industrial IoT-ready**
- **High-torque machine performance**
- **Superior motor control**
- **High power density with a small footprint**

## Intelligence

to empower your application





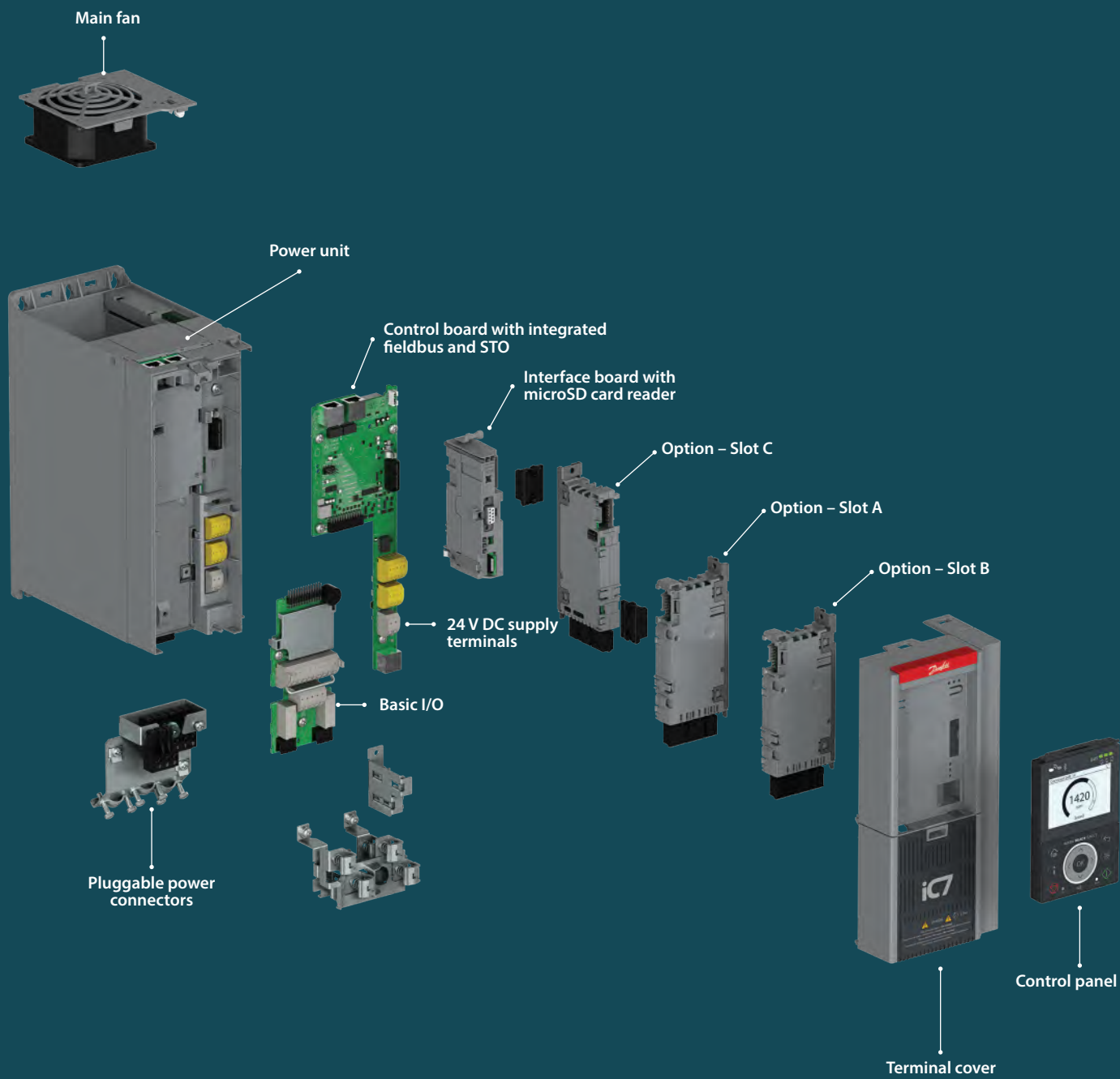

*iC7 series frequency converter, frame FA03b*

# Configured to your needs

The iC7 drive is configured and delivered to meet your exact requirements, saving expensive installation time. Everything can be integrated: EMC and harmonic filter, brake chopper and DC terminals. Fuse and disconnect are also available built-in, for IP21/UL Type 1 and IP54/UL Type 12 enclosures.

Control is highly configurable and preconfigured at the factory or can easily be upgraded in the field.

## Enclosures fit for installation

Install this space-saving drive easily in cabinets and protected rooms:

- Bookstyle IP20/UL Open Type optimized in width for side-by-side mounting without clearance, to save cabinet space  
(Frames FA02-FA12)
- Designed for flexible installation with minimum use of space
  - IP21/UL Type 1 for frames FK06-FK12
  - IP54/UL Type 12 for frames FB09-FB12

## High power density cooling

You get high power density thanks to superior heat management using heat-pipe technology and high-performance heat sinks. Closed air ducts enable flexible mounting, and back-channel cooling supports removal of heat to the surroundings without extra cooling equipment. Remove fans easily for cleaning and service.

## Fast installation and service

Focus on ease of installation and service has been a key driver during development, with intensive installation testing during the design phase to ensure easy installation and user access.

Control connectors are pluggable. Power connectors are also pluggable for units up to 43 A (22 kW). Connectors are color-coded and clearly marked for easier identification.

Power connectors are rated for use of copper cable at full current plus 25%, matching updated installation standards.

## Environmental exposure

The iC7 drive delivers exceptional performance under demanding operating conditions, and its design criteria match the environments described in the IEC60721 standard.

The ability to operate at ambient temperatures ranging from -30 °C to 50 °C (60 °C with derating) ensures the drive meets a broad range of application requirements. With an altitude capability of up to 4400 m (14400 ft) above sea level, you can install this drive in virtually any location. For additional protection, specify the optional coated printed circuit boards increasing corrosion resistance.

This robust drive matches the required vibration resistance for operation in cabinets, in control rooms and on machines.

## Next-level reliability

- Temperature -30 to +50 °C
- Altitude 4400 m
- Optional coated PCBs for increased protection



## Features and benefits

Feature	Benefit
Compact side-by-side mounting	Save space and reduce installation costs
Compact bookshelf design reduces footprint	Reduce space requirement and air-conditioning load
Isolated cooling channel minimizes required installation space	
Integrated options such as functional extensions, common-mode filters, fuses and disconnects mean no extra external devices are required	Save cost and time in installation
Installer-friendly design includes pluggable control terminals, pluggable power terminals <sup>1)</sup> , and replaceable fans	Save cost and time in installation and service
Robust by design, high uptime and quality	Reliable in heavy-duty service

<sup>1)</sup> For frames up to FA05.

Ensuring you shine in the marketplace is our goal. Learn how Danfoss supports your success [here](#) 



## Key specifications

Input	
Voltage rating	380-500 V AC, +10%/-15%
Supply frequency	50/60 Hz
Switching on input	1-2 times pr. minute
Grid type	TN, TT, IT, Delta

Output	
Output frequency	0-590 Hz
Switching on output	Unlimited
Overload capacity	110% and 150/160%

Protection ratings	
Frames Fx09	IP20 – UL Open Type
Frames Fx08	IP21 – UL Type 1
Frames Fx12	IP54 – UL Type 12

Environmental conditions	
Rated temperature	-30 to 50 °C (-22 to 122 °F) <sup>1)</sup>
Nominal temperature 24 hours	-30 to 45 °C (-22 to 113 °F) <sup>1)</sup>
Maximum temperature with derating	60 °C (140 °F)
Rated altitude	1000 m (3300 feet)
Maximum altitude	4400 m (14400 feet) with derating
Relative humidity	3K22, maximum 95% non-condensing
Particles (IEC 60721-3-3:2019)	Solid particles (nonconductive particles/dust) 3S6
Chemically active substances (IEC 60721-3-3:2019, ISO 9223:2012)	– C3 (P1) – Medium corrosivity – Non coated – C4 (P2) – High corrosivity – Coated in IP54/IP55/UL Type 12 enclosure or for IP20/UL Open Type and IP21/UL Type 1 following installation guidance.
Shock & vibration (IEC 60721-3-3:2019)	3M12

Functional Safety I/O	
STO	Dual-channel, with galvanic isolation
STO feedback	Single channel, with galvanic isolation

External supply	
Rating	24 V/2 A

Basic I/O	
Digital inputs	4+2 <sup>2)</sup>
– Logic	NPN/PNP selectable – 0/24V
– Pulse/Encoder input	0-110 kHz

Digital outputs	2 <sup>2)</sup>
– Logic	NPN/PNP selectable – 0/24V
– Pulse output	0-100 kHz

Analog inputs	2
Voltage mode	0-10 or ±10V, scalable
Current mode	0/4-20 mA
Relay output	2
Function	NO/NC
Rating	250V AC 2 A, 24V DC 2 A

Analog output	0/4-20 mA
---------------	-----------

<sup>1)</sup> Frames Fx09-Fx12: For low overload conditions, the maximum permissible ambient air temperatures without derating are 40 °C (104 °F) average over 24 hours duration; and 45 °C (113 °F) for 1 hour duration, respectively.

<sup>2)</sup> 2 of the inputs can be reconfigured to outputs

EMC category (model code)	Frame	EN/IEC 61800-3 compliance class					
		Conducted emission			Radiated emission		
		C1	C2	C3	C1	C2	C3
F1 – Combined C1 and C2 filter	Fx02–Fx08	50 (164)	150 (492)	150 (492)	No	Yes	Yes
F2 – C2 filter	Fx02–Fx08	–	150 (492)	150 (492)	No	Yes	Yes
	Fx09–Fx12	–	150 (492)	150 (492)	No	Yes	Yes
F3 – C3 filter	Fx02–Fx05	–	–	250 (820)	No	No	Yes
	Fx06–Fx08	–	–	300 (984)	No	No	Yes
	Fx09–Fx12	–	–	150 (492)	No	No	Yes

For information on functional extension option slots, go to page 14

## Ratings Fx02-Fx12 – High overload

Designation	Rated output current						Typical shaft output power		Frame
	3 x 380-440 V			3 x 441-500 V			400 V	460 V	
	$I_L$	$I_H$	$I_{H2}$	$I_L$	$I_H$	$I_{H2}$	$P_H$	$P_H$	
	[A]	[A]	[A]	[A]	[A]	[A]	[kW]	[HP]	
01A3	1.3	1.3	0.9	1.2	1.2	0.8	0.37	0.5	Fx02
01A8	1.8	1.8	1.3	1.6	1.6	1.1	0.55	0.75	
02A4	2.4	2.4	1.8	2.1	2.1	1.6	0.75	1.0	
03A0	3.0	3.0	2.4	2.7	2.7	2.1	1.1	1.5	
04A0	4.0	4.0	3.4	3.4	3.4	3.0	1.5	2.0	
05A6	5.6	5.6	4.3	4.8	4.8	3.4	2.2	3.0	
07A2	7.2	7.2	5.6	6.3	6.3	4.8	3.0	4.0	
09A2	9.2	9.2	8.0	8.2	8.2	6.3	4.0	5.0	
12A5	12.5	12.5	10	11	11	7.6	5.5	7.5	
16A0	16	16	13	14.5	14.5	11	7.5	10	Fx03
24A0	24	24	17	21	21	14.5	11	15	Fx04
31A0	31	31	25	27	27	21	15	20	
38A0	38	38	32	34	34	27	18.5	25	Fx05
43A0	43	43	38	40	40	34	22	30	
61A0	61	61	46	55	55	40	30	40	Fx06
73A0	73	73	61	66	66	55	37	50	
90A0	90	90	73	81	81	66	45	60	Fx07
106A	106	106	90	96	96	81	55	75	
147A	147	147	106	133	133	96	75	100	Fx08
170A	170	170	147	156	156	133	90	125	
206A	206	170	147	196	166	156	90	125	Fx09
245A	245	206	170	240	196	166	110	150	
302A	302	245	206	302	240	196	132	200	
385A <sup>1)</sup>	385	302	245	364	302	240	160	250	
395A	395	302	245	364	302	240	160	250	Fx10
480A	480	385	302	456	364	302	200	300	
588A	588	480	385	520	456	364	250	350	
658A	658	588	480	590	520	456	315	450	Fx11
736A	736	658	588	658	590	520	355	500	
799A	799	695	658	730	653	590	400	550	
893A	893	799	736	784	700	653	450	550	Fx12
1000	1000	880	799	896	784	700	500	650	
1120	1120	1000	893	1028	896	784	560	750	
1260	1260	1100	1000	1150	1028	896	630	850	

<sup>1)</sup> 385A is without brake or disconnect. If brake or disconnect is required, select 395A

$I_L$ : Rated continuous output current with 110% overload capacity – 1 min every 10 min

$I_H$ : Rated continuous output current with 150/160% overload capacity – 1 min every 10 min

$I_{H2}$ : Rated continuous output current with 150/160% overload capacity with increased duty – 1 min every 5 min

$P_H$ : Typical nominal motor power with 150/160% overload capacity

Ratings Fx09-Fx12 – Low overload <sup>1)</sup>

Designation	Rated output current						Typical shaft output power		Frame
	3 x 380-440 V			3 x 441-500 V			400 V	460 V	
	$I_L$	$I_H$	$I_{H2}$	$I_L$	$I_H$	$I_{H2}$	$P_L$	$P_L$	
	[A]	[A]	[A]	[A]	[A]	[A]	[kW]	[HP]	
206A	206	170	147	196	166	156	110	150	Fx09
245A	245	206	170	240	196	166	132	200	
302A	302	245	206	302	240	196	160	250	
385A <sup>1)</sup>	385	302	245	364	302	240	200	300	
395A	395	302	245	364	302	240	200	300	Fx10
480A	480	385	302	456	364	302	250	350	
588A	588	480	385	520	456	364	315	450	
658A	658	588	480	590	520	456	355	500	Fx11
736A	736	658	588	658	590	520	400	550	
799A	799	695	658	730	653	590	450	600	
893A	893	799	736	784	700	653	500	650	Fx12
1000	1000	880	799	896	784	700	560	750	
1120	1120	1000	893	1028	896	784	630	850	
1260	1260	1100	1000	1150	1028	896	710	950	

<sup>1)</sup> 385A is without brake or disconnect. If brake or disconnect is required, select 395A

$I_L$ : Rated continuous output current with 110% overload capacity – 1 min every 10 min

$I_H$ : Rated continuous output current with 150/160% overload capacity – 1 min every 10 min

$I_{H2}$ : Rated continuous output current with 150/160% overload capacity with increased duty – 1 min every 5 min

$P_L$ : Typical nominal motor power with 110% overload capacity

## Options

Functional extensions	Description
General Purpose I/O OC7C0	General purpose I/O extension board: 3 digital inputs 2 digital outputs 2 analog inputs 1 analog output
Relay Option OC7R0	Relay I/O extension board, with 3 relays
Encoder/Resolver Option OC7M0	Encoder/Resolver extension board supports 1 or 2 encoders (TTL, HTL, SinCos, SSI, HIPERFACE®, HIPERFACE DSL®, EnDat, BiSS, resolver)





READY



ARMED AND READY TO PROTECT  
FROM ALL THREATS  
FOR THE  
ACCESS ONLY

ARMED AND READY TO PROTECT  
FROM ALL THREATS  
FOR THE  
ACCESS ONLY

ARMED AND READY TO PROTECT  
FROM ALL THREATS  
FOR THE  
ACCESS ONLY



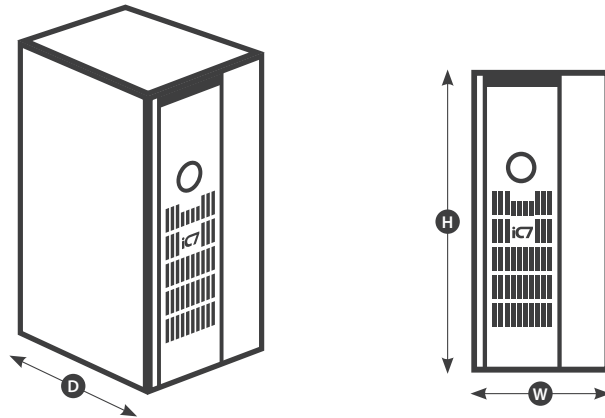

## Dimensions and weight

Frame		FA02a	FA03a	FA04a	FA05a	FA06	FK06	FA07	FK07	FA08	FK08
[mm]	Width	90	114	130	165	200	210	230	240	255	270
	Height	270	270	399	399	555	670	600	770	746	980
	Depth	221	221	262	269	294	297	308	327	368	365
[kg]	Weight	4.7	5.7	11.6	14.1	26	28	35	38	55	60
[in]	Width	3.5	4.5	5.1	6.5	7.9	8.3	9.1	9.5	10.0	10.6
	Height	10.6	10.6	15.7	15.7	21.9	26.4	23.6	30.3	29.4	38.6
	Depth	8.7	8.7	10.3	10.6	11.6	11.7	12.1	12.9	14.0	14.4
[lb]	Weight	10.4	12.6	25.6	31.1	57	61	77	83	121	132

Frames FA02b to FA05b: Add 26 mm (1 in) to depth.  
Outer dimensions include mounting flange, without EMC shield plates.  
Weight is maximum weight.

Frame		FA09	FK09a/ FB09a	FK09c/ FB09c	FA10	FK10a/ FB10a	FK10c/ FB10c	FA11	FK11/ FB11	FA12	FK12/ FB12
[mm]	Width	250	325	325	350	420	420	508	602	604	698
	Height	909	1001	1421	1122	1232	1779	1578	2043	1578	2043
	Depth	370	378	381	370	378	381	482	513	482	513
[kg]	Weight	81	84	107	127	137	174	225	272	298	320
[in]	Width	9.8	12.8	12.8	13.8	16.5	16.5	20	23.7	23.9	27.5
	Height	35.8	39.4	55.9	44.2	48.5	70.0	62.1	80.4	62.1	80.4
	Depth	14.8	14.9	15.0	14.6	14.9	15.0	19.0	20.2	19.0	20.2
[lb]	Weight	179	184	236	280	302	384	496	600	654	705

Weight is maximum weight.

# Model code overview: iC7 frequency converter

For more detailed information, refer to the Design Guide



[1-2] Product group (character 1-6)	
iC7-60	Indication of product group performance
[3] Product category (character 7)	
F	Frequency converter
[4] Cooling method (character 8)	
A	Air-cooled
[5] Product type (character 9-10)	
3N	Three-phase 6-pulse
[6] Voltage rating (character 11-12)	
05	380-500 V AC
[7] Nominal Amp rating <sup>2)</sup> (character 14-17)	
01A3	1.3 A
01A8	1.8 A
02A4	2.4 A
03A0	3.0 A
04A0	4.0 A
05A6	5.6 A
07A2	7.2 A
09A2	9.2 A
12A5	12.5 A
16A0	16 A
24A0	24 A
31A0	31 A
38A0	38 A
43A0	43 A
61A0	61 A
73A0	73 A
90A0	90 A
106A	106 A
147A	147 A
170A	170 A
206A	206 A
245A	245 A
302A	302 A
385A	385 A
395A	395 A
480A	480 A
588A	588 A
658A	658 A
736A	736 A
799A	799 A
893A	893 A
1000	1000 A
1120	1120 A
1260	1260 A

<sup>1)</sup> +codes identifying options  
<sup>2)</sup> See rating tables on pages 9-10

[8] Frame (character 18-20)		Fx02-05	Fx06-08	Fx09-12
E20	IP20/Open Type	■	■	■
E21	IP21/UL Type 1		■	■
E54	IP54/UL Type 12			■
[9] EMC Class (character 21-22)				
F1	C1 and C2 category	■	■	
F2	C2 category	■	■	■
F3	C3 category	■	■	■
[10] +code group				
+Axxx	Optional power hardware			
+Bxxx	Control hardware			
+Cxxx	Control options			
+Dxxx	Application software and additional functionality			
+Exxx	Customized settings (for reference only)			

## +Axxx Optional power hardware IP20

Function	Model code	Selection description	Fx02-05	Fx06-08	Fx09-12
Integrated brake chopper	+ACXX	None	-	X	X
	+ACBC	Yes <sup>1)</sup>	X	X	O <sup>2)</sup>
Extra environmental protection	+AGXX	None	X	X	-
	+AGCX	Coated boards	O	O	X
Mains input device	+AJXX	None	X	X	X
	+AJFX	AC fuses	-	-	O
DC terminals	+ALXX	None	-	X	X
	+ALDC	Yes	X	O	O <sup>2)</sup>
Heat sink access panel	+APXX	None	X	X	X
	+APHS	Yes	-	-	O

<sup>1)</sup> Not applicable to model 05-385A.  
<sup>2)</sup> DC terminals and brake chopper cannot be combined.

## +Axxx Optional power hardware IP21

Function	Model code	Selection description	Fx02-05	Fx06-08	Fx09-12
Cable entry and EMC plate	+AAST	Standard, no holes	-	X	X
Integrated brake chopper	+ACXX	None	-	X	X
	+ACBC	Yes <sup>1)</sup>	-	O <sup>2)</sup>	O <sup>3)</sup>
Extra environmental protection	+AGXX	None	-	X	-
	+AGCX	Coated boards	-	O	X
Humidity protection device	+AHXX	None	-	X	X
	+AHHX	Space heater	-	-	O
Mains input device	+AJXX	None	-	X	X
	+AJFX	AC fuses	-	O <sup>2)</sup>	O
	+AJXD	Mains switch	-	-	-
DC terminals	+AJFD	AC fuses and mains switch	-	O <sup>2)</sup>	O
	+ALXX	None	-	X	X
Touch protection	+ALDC	Yes	-	O <sup>2)</sup>	O <sup>3)</sup>
	+AMXX	None	-	X	X
Heat sink access panel	+AMMX	Yes	-	-	O
	+APXX	None	-	X	X
	+APHS	Yes	-	-	O

<sup>1)</sup> Not applicable to model 05-385A.  
<sup>2)</sup> Integrated brake chopper and DC terminals cannot be combined with Mains input device (AC fuses and mains switch).  
<sup>3)</sup> DC terminals and brake chopper cannot be combined. DC and brake are not available in FK09a and FK10a frames.

X indicates a standard selection  
O indicates an optional selection  
A dash (-) indicates that the selection is not available





### +Bxxx Control board features

Function	Model code	Selection description	Fx02-05	Fx06-08	Fx09-12
Communication interface, X1/X2	+BAMT	Modbus TCP OS7MT	■	■	■
	+BAPR	PROFINET RT OS7PR	■	■	■
	+BAIP	EtherNet/IP OS7IP	■	■	■
Standard I/O	+BDXX	None	■	■	■
	+BDBA	Basic I/O (4 x DI, 2 x combined DI/DO, 2 x AI, 1 x AO, 2 x relay)	■	■	■
Control panel	+BF00 <sup>1)</sup>	Blind Panel OPX00	■	■	
	+BF20	Control Panel 2.8 OPX20	■	■	■

### +Cxxx Control options

Functional extension option slots							
Frame	FA02a	FA02b	FA03a FA04a	FA03b FA04b	FA05a	FA05b	FA06-FA12
Number of option slots	1	2	1	3	1	4	4
Option slot A	■	■	■	■	■	■	■
Option slot B		■		■		■	
Option slot C				■		■	■
Option slot D						■	■
Option slot E							■

Control options (character >2)	
+CBXX	None – Not upgradable <sup>1)</sup>
+C_X0	None <sup>2)</sup>
+C_C0	General Purpose I/O OC7C0
+C_R0	Relay Option OC7R0
+CAM0	Encoder/Resolver Option OC7M0 <sup>3)</sup>

<sup>1)</sup> Only selectable for option slot B

<sup>2)</sup> +CBX0 will not appear in the model code if "None" is selected for option slot B

<sup>3)</sup> Encoder/Resolver Option must be in option slot A

### +Dxxx Application software and additional functionality

Function & code	Fx02-05	Fx06-08	Fx09-12
Additional drive feature	+DD1X	None <sup>1)</sup>	■
	+DD11	Motion	■

<sup>1)</sup> +DD1X will not appear in the model code if "None" is selected for option slot B

# System Modules

## Need flexibility to create more competitive systems?

iC7 series offers powerful air-cooled and liquid-cooled system modules ideal for saving space in cabinet configuration. The modular concept with integration unit facilitates extreme compactness.

A flexible, modular, control architecture means you can tailor the control functionality exactly to your needs. You can purchase exactly the control options you need, or replace other PLC components, I/O and external safety components.

This modularity gives you not only more flexibility, but more secure integration of drives in the control

system and IT architecture. You achieve faster set-up, and smarter monitoring, data gathering and analytics thanks to support for multiple communication network types.

The purchase cost is lower since you only buy the necessary control options, saving excess unused functionality. The drive can reduce your costs further by substituting for a low-end PLC controller/system.

Program execution close to the process opens new possibilities in fast process control thanks to reduced delays. Built-in security protects your IPR and service business.

### Features

- Expandable bus includes I/O, fieldbus, and expanded safety

Control mounting plate mechanics

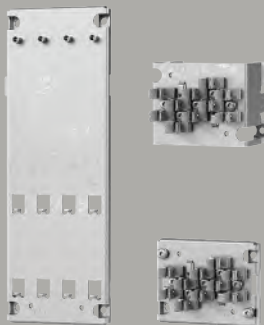

Control and option boards

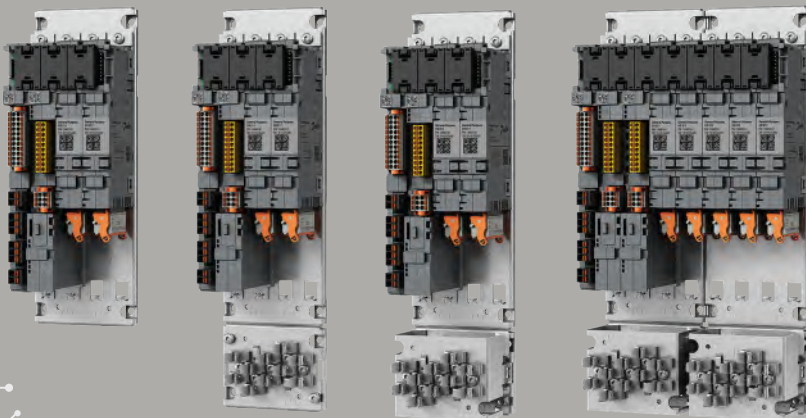
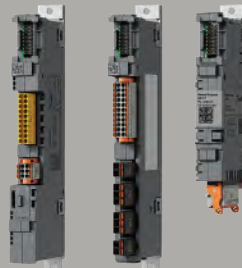

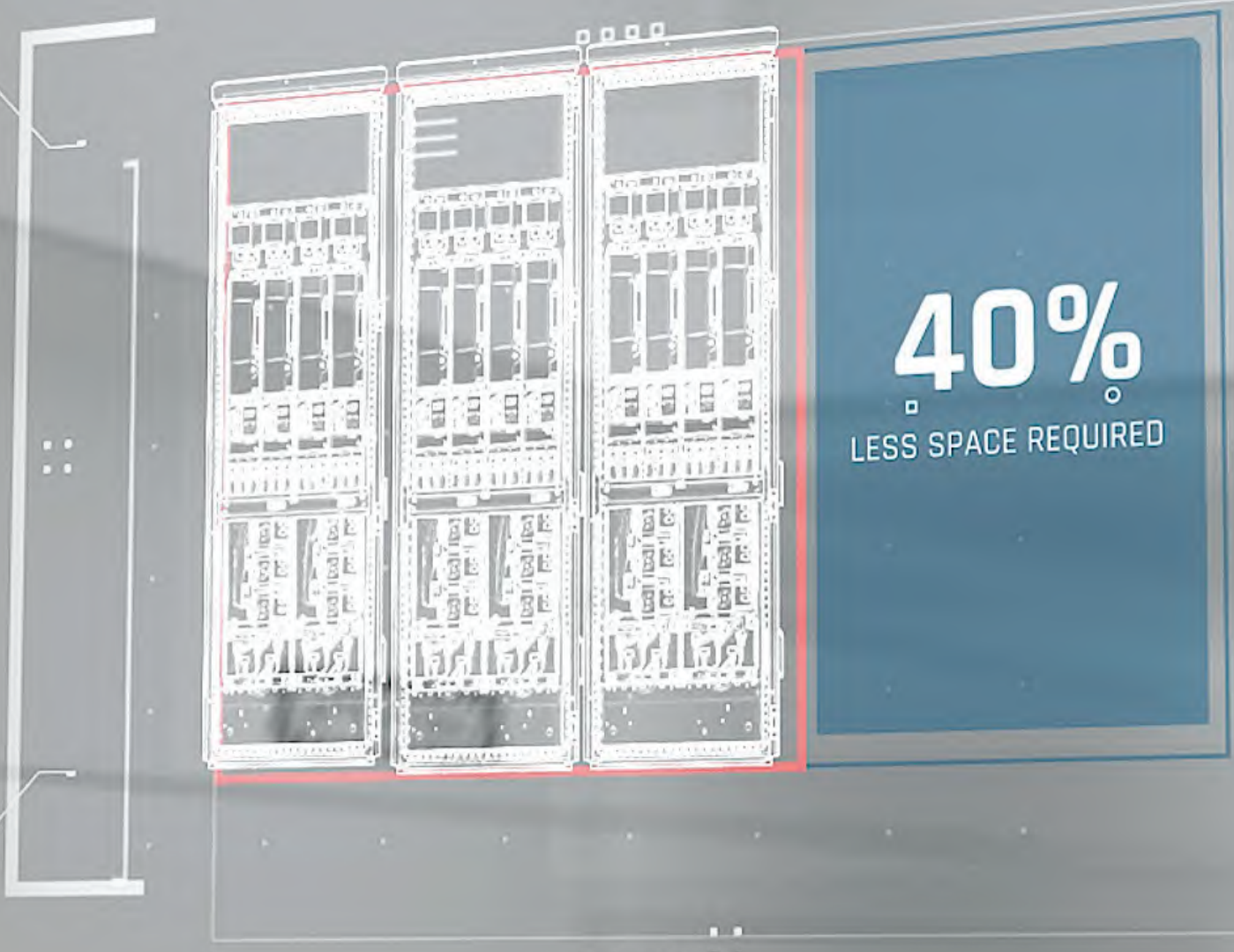

- options
- Up to 10 control options
- Slot-independent options
- Integrated microSD card slot
- Integrated STO SIL3 safety
- Programmable (IEC 61131- based)
- Use the same options for iC7 series air-cooled system modules, liquid-cooled system modules and enclosed drives

**Technical information**

- Integrated Ethernet port
- Dual-channel STO SIL3 integrated

- as standard
- Modbus TCP as standard and other fieldbus protocols optional
- Basic I/O: 6x DI, 2x DO, 2x AI +/-10V/0-20 mA, 1x AO (0-10/4-20 mA), 2x NO/NC RO, 1x NO RO, 1x Thermistor
- One optical fiber pair as communication link with power module or star coupler board
- For more options such as voltage measurement, temperature measurement, relay option, and

encoder option, refer to the Functional extensions fact sheet.

**Functional extensions**



# Air-cooled System Modules

## Is fast integration your first priority?

Optimize installation footprint, speed and reduce costs more than you dreamed possible, with the revolutionary iC7 series air-cooled system modules.

High power density combined with industry-leading heat-pipe thermal management means you achieve a smaller footprint and reduce space requirements in your electrical room. The slim profile enables you to fit more modules within a fixed-width cabinet. Shrink your system, with smaller enclosures or fewer enclosure sections, and filters which integrate beneath the module.

Integration and scalability are extremely easy, because each unit is designed and tested in thermal independence. This reduces your engineering, assembly, and testing time.

Thermal excellence saves your operating costs with the unique segregated IP54 cooling channel, and reduced heat load in your installation. With the iC7 series air-cooled

system modules, you enjoy industry benchmark cooling efficiency, even including the thermal load of optionally integrated filters and chokes. Configure your choice of common-mode and dU/dt filter options in the integration unit located beneath the module.

With the integration unit, access is so easy: simply pull out the power unit, with no need to remove the power cable. Power terminals are located at the front for easy access.

## HIGHLIGHTS

- **Highly compact power unit design requires less space for installation**
- **Increase power by paralleling power units with no need for balancing filters**
- **Integration unit with built-in filters reduces integration cost**
- **Fast power unit replacement with no need for motor cable removal**
- **Front-mounted motor cable terminals**
- **Lightweight power units facilitate faster and easier servicing**
- **Modular and scalable control concept**
- **Efficient heat management with back-channel cooling**

Reduce your engineering effort  
to deliver fast and deliver

**first**



# Features and benefits

Feature	Benefit
Efficient heat management: heat pipe technology and segregated main cooling channel (back-channel cooling)	- Compact size enables you to pack more power into the space available
Paralleling of 3-phase modules with no output filter required	- Modular and scalable solutions for high powers - Simplified spare unit handling
Lightweight	- Fast integration and serviceability - High vibration robustness
Optional integration unit for output filter integration, enabling back-channel cooling	- Compact size enables you to pack more power into the space available - Fast integration
Pull-out of power unit without removing motor or mains cables, included with integration unit	- Fast integration and serviceability
AuxBus internal network for temperature monitoring of filters	- Exceptional reliability and robustness for increased uptime
Segregated IP54 cooling channel and dedicated PCB area	- Extremely reliable in heavy-duty service, for increased uptime

## Air-cooled module



**Inverter module**  
IM10



**Inverter module**  
with short  
integration  
unit IR10



**Inverter module**  
with standard  
integration  
unit IR10



**Inverter module**  
IM11



**Inverter module**  
with short  
integration  
unit IR11



**Inverter module**  
with standard  
integration  
unit IR11



**AFE Module**  
with short  
integration unit



**AFE module**  
with integration  
unit AR10/AR11



**AFE & LCL filter**  
with standard  
integration  
unit IR10/IR11



**LCL filter**  
LCL 10/11



## Key specifications

Mains connection AFE	
Mains voltage $U_{in}$	– 3 x 380-500 V AC (-15%...+10%); 465-740 V DC
Mains frequency	– 45-66 Hz
Supply network	– TN-S, TN-C, IT and TT
Power factor	– $\cos\phi = 1$ : (fundamental)
Short circuit current	– Maximum short circuit current must be < 100 kA
Total harmonics distortion THDi	– < 5%
Overvoltage category	– Class III according to IEC/EN 61800-5-1
Connections to mains	– Once every 120 s
Motor connection (INU)	
Output voltage	– 0- $U_{in}$ , 3-phase
Output frequency	– 0-599 Hz ( <i>Limited performance with output filters above 70 Hz</i> )
Switching frequency	– 1.5-10 kHz. Default switching frequency 3 kHz DPWM
Motor control principles	– U/f control – Voltage Vector Control (VVC+) – Flux Vector Control (FVC+)
Motor and generator types supported	– Induction/asynchronous motor – Permanent magnet motor – Salient permanent magnet motor – Synchronous reluctance assisted permanent magnet motor
Cable length	– Up to 150 m [492 feet] with symmetrical 3-phase screened motor cable
EMC (IEC61800-3)	
Immunity	– Fulfils IEC/EN61800-3 (2018), 2nd environment
Emissions	– IEC/EN61800-3 (2018), category C4, default for the IP00/UL Open Type drive – IEC/EN61800-3 (2018), category C3, if the drive is installed according to the instructions of the manufacturer
Environmental conditions	
Protection rating drive modules	– IP00/UL Open Type
Ambient operating temperature	– -15 °C to 0 °C (5 °F to 32 °F) (no frost) The highest current rating of AM11 and IM11 must be derated 20% in freezing conditions. – 0 °C to 40 °C (32 °F to 104 °F) (at $I_N$ ) with derating up to +15 °C (131 °F)
Storage/transportation temperature	– -40 °C to +70 °C (32 °F to 158 °F)
Relative humidity	– 5 to 96% RH, no dripping water or condensation allowed
Pollution degree	– PD2
Altitude	– 0–4000 m (0–13100 ft) above sea level: in case network is not corner-grounded (Voltage class 5). – Above 1000 m (3300 ft): derating of maximum ambient operating temperature by 1 °C per each 100 m is required.
Vibration (IEC60068-2-6)	– Displacement amplitude 0.5 mm (peak) at 5–22 Hz – Maximum acceleration amplitude 1 G at 22–150 Hz
Shock (IEC60068-2-27)	– Max 15G, 11 ms ( <i>in package</i> )
Environmental operating conditions (IEC 60721-3-3)	– Climatic conditions: Class 3K5 – Chemically active substances: IEC 60721-3-3 Edition 3.0/ISO 3223 Second Edition, class C4 – Biological conditions: Class 3B1 – Mechanical conditions: Class 3M3 – Mechanically active substances: Class 3S2 – Special climatic conditions (heat radiation): Class 3Z1

# Inverter module (INU)



## Inverter module (INU)

The inverter module is a bidirectional DC-fed power inverter for the supply and control of AC motors and generators.

The inverter (INU) module is intended for the regulation of motor speed in response to system feedback or to remote commands from external controllers. A drive system consists of the system modules, the motor, and equipment driven by the motor. The INU module is also intended for system and motor status surveillance.

## Benefits of the Inverter module

- Designed for maximum machine performance and flexibility
- Versatility for drive applications requiring a wide range of drive features for different motor types for either closed loop or open loop control methods

- Optional system module with integration unit including high performance dU/dt filters and/or common-mode filters for space saving and easy cabinet integration

## Ratings

- 385-4870 A  $I_L$ , +10% overload 1 min/5 min
- 380-500 V AC Motor Voltage
- Output frequency: 0-599 Hz
- Switching frequency: 1,5-10 kHz. Nominal 3 kHz

## Highlights

- Most compact INU module on the market thanks to integration of filters
- IP54/Type 12 segregated main cooling channel supporting back-channel cooling solutions
- Designed for enclosure integration and quick serviceability
- Integration of common-mode and dU/dt filters in the integration unit
- Slide-in philosophy for power unit installation means you can remove the power unit without disconnecting the motor cable

## Motor control

- Highly dynamic performance: Highest possible machine accuracy due to superior shaft performance, also for sensorless operation
- Superior low-speed performance also in sensorless operation
- The motor always runs at maximum possible torque for the given current – ensuring highest possible motor efficiency: Maximum Torque Per Ampere (MTPA)
- Fast commissioning using Automatic Motor Adaption (AMA) at standstill maximizes energy efficiency with any motor
- More integrated sensors for better performance
- Flexible choice of control features optimized to your application, thanks to integrated application software

Inverter module <sup>1)</sup>

400 V AC, 465-650 V DC

Model code	AC current				Typical motor power 400 V AC		DC current	Frame
	$I_N$	$I_L (1/5)$	$I_H (1/5)$	$I_{max (3s)}$	$P_L$	$P_H$	$I_{N-DC}$	IP00
	[A]	[A]	[A]	[A]	[kW]	[kW]	[A]	
iC7-60SAIN05-385AE00	394	385	320	544	200	160	410	IM/IR10
iC7-60SAIN05-480AE00	490	480	399	679	250	200	510	IM/IR10
iC7-60SAIN05-590AE00	603	590	490	833	315	250	641	IM/IR10
iC7-60SAIN05-658AE00	672	658	547	930	355	250	721	IM/IR11
iC7-60SAIN05-730AE00	746	730	606	1031	400	315	813	IM/IR11
iC7-60SAIN05-820AE00	838	820	681	1158	450	355	913	IM/IR11
iC7-60SAIN05-880AE00	899	880	731	1243	500	400	1015	IM/IR11
iC7-60SAIN05-1000E00	1021	1000	830	1411	560	450	1138	2xIM/IR10
iC7-60SAIN05-1100E00	1123	1100	913	1553	630	500	1280	2xIM/IR10
iC7-60SAIN05-1260E00	1287	1260	1050	1785	710	560	1441	2xIM/IR11
iC7-60SAIN05-1450E00	1481	1450	1210	2057	800	630	1625	2xIM/IR11
iC7-60SAIN05-1710E00	1746	1710	1420	2414	900	710	1826	2xIM/IR11
iC7-60SAIN05-1760E00	1797	1760	1470	2499	1000	800	2030	3xIM/IR11
iC7-60SAIN05-1960E00	2001	1960	1630	2771	1100	900	2234	3xIM/IR11
iC7-60SAIN05-2150E00	2195	2150	1790	3043	1200	1000	2436	3xIM/IR11
iC7-60SAIN05-2340E00	2389	2340	1950	3315	1300	1000	2639	3xIM/IR11
iC7-60SAIN05-2510E00	2563	2510	2090	3553	1400	1100	2841	3xIM/IR11
iC7-60SAIN05-2640E00	2695	2640	2200	3740	1500	1200	3045	4xIM/IR11
iC7-60SAIN05-2880E00	2940	2880	2400	4080	1600	1300	3247	4xIM/IR11
iC7-60SAIN05-3060E00	3124	3060	2540	4318	1700	1400	3450	4xIM/IR11
iC7-60SAIN05-3280E00	3349	3280	2730	4641	1800	1500	3652	4xIM/IR11
iC7-60SAIN05-3420E00	3492	3420	2840	4828	1900	1500	3856	5xIM/IR11
iC7-60SAIN05-3600E00	3675	3600	2990	5083	2000	1600	4058	5xIM/IR11
iC7-60SAIN05-4060E00	4145	4060	3370	5729	2200	1800	4465	5xIM/IR11
iC7-60SAIN05-4320E00	4410	4320	3590	6103	2400	1900	4871	6xIM/IR11
iC7-60SAIN05-4870E00	4972	4870	4050	6885	2700	2200	5478	6xIM/IR11

<sup>1)</sup> Preliminary values subject to validation $I_L$ : Low overload – 110% overload – 1 min every 5 min $I_H$ : High overload – 150% overload – 1 min every 5 min

# Inverter module <sup>1)</sup>

460 V AC, 650-740 V DC

Model code	AC current				Typical motor power 460 V AC		DC current	Frame
	$I_N$	$I_L (1/5)$	$I_H (1/5)$	$I_{max (3s)}$	$P_L$	$P_H$	$I_{N-DC}$	IP00
	[A]	[A]	[A]	[A]	[Hp]	[Hp]	[A]	
iC7-60SAIN05-385AE00	394	385	320	544	300	250	380	IM/IR10
iC7-60SAIN05-480AE00	490	480	399	679	350	300	443	IM/IR10
iC7-60SAIN05-590AE00	543	531	441	750	450	350	570	IM/IR10
iC7-60SAIN05-658AE00	603	590	490	833	500	350	632	IM/IR11
iC7-60SAIN05-730AE00	672	658	547	930	550	450	695	IM/IR11
iC7-60SAIN05-820AE00	746	730	606	1031	600	500	758	IM/IR11
iC7-60SAIN05-880AE00	838	820	681	1158	700	550	883	IM/IR11
iC7-60SAIN05-1000E00	940	920	764	1299	750	550	948	2xIM/IR10
iC7-60SAIN05-1100E00	1052	1030	855	1454	850	650	1073	2xIM/IR10
iC7-60SAIN05-1260E00	1174	1150	960	1632	950	750	1200	2xIM/IR11
iC7-60SAIN05-1450E00	1328	1300	1080	1836	1100	850	1389	2xIM/IR11
iC7-60SAIN05-1710E00	1603	1570	1310	2227	1300	1100	1641	2xIM/IR11
iC7-60SAIN05-1760E00	1807	1770	1470	2499	1500	1200	1892	3xIM/IR11
iC7-60SAIN05-1960E00	1940	1900	1580	2686	1600	1300	2021	3xIM/IR11
iC7-60SAIN05-2150E00	2083	2040	1700	2890	1700	1300	2146	3xIM/IR11
iC7-60SAIN05-2340E00	2195	2150	1790	3043	1800	1500	2272	3xIM/IR11
iC7-60SAIN05-2510E00	2389	2340	1950	3315	1900	1600	2397	3xIM/IR11
iC7-60SAIN05-2640E00	2532	2480	2060	3502	2100	1700	2650	4xIM/IR11
iC7-60SAIN05-2880E00	2685	2630	2190	3723	2200	1800	2775	4xIM/IR11
iC7-60SAIN05-3060E00	2828	2770	2300	3910	2300	1800	2902	4xIM/IR11
iC7-60SAIN05-3280E00	3114	3050	2540	4318	2500	2100	3155	4xIM/IR11
iC7-60SAIN05-3420E00	3277	3210	2670	4539	2700	2200	3406	5xIM/IR11
iC7-60SAIN05-3600E00	3573	3500	2910	4947	2900	2300	3658	5xIM/IR11
iC7-60SAIN05-4060E00	3859	3780	3140	5338	3200	2500	4036	5xIM/IR11
iC7-60SAIN05-4320E00	4176	4090	3400	5780	3400	2700	4289	6xIM/IR11
iC7-60SAIN05-4870E00	4625	4530	3760	6392	3700	2900	4667	6xIM/IR11

<sup>1)</sup> Preliminary values subject to validation

$I_L$ : Low overload – 110% overload – 1 min every 5 min

$I_H$ : High overload – 150% overload – 1 min every 5 min



Inverter module <sup>1)</sup>

500 V AC, 650-740 V DC

Model code	AC current				Typical motor power 500 V AC		DC current	Frame
	$I_N$	$I_L (1/5)$	$I_H (1/5)$	$I_{max (3s)}$	$P_L$	$P_H$	$I_{N-DC}$	IP00
	[A]	[A]	[A]	[A]	[kW]	[kW]	[A]	
iC7-60SAIN05-385AE00	394	385	320	544	250	200	408	IM/IR10
iC7-60SAIN05-480AE00	490	480	399	679	315	250	513	IM/IR10
iC7-60SAIN05-590AE00	543	531	441	750	355	250	577	IM/IR10
iC7-60SAIN05-658AE00	603	590	490	833	400	315	651	IM/IR11
iC7-60SAIN05-730AE00	672	658	547	930	450	355	731	IM/IR11
iC7-60SAIN05-820AE00	746	730	606	1031	500	400	812	IM/IR11
iC7-60SAIN05-880AE00	838	820	681	1158	560	450	910	IM/IR11
iC7-60SAIN05-1000E00	940	920	764	1299	630	500	1024	2xIM/IR10
iC7-60SAIN05-1100E00	1052	1030	855	1454	710	560	1153	2xIM/IR10
iC7-60SAIN05-1260E00	1174	1150	960	1632	800	630	1300	2xIM/IR11
iC7-60SAIN05-1450E00	1328	1300	1080	1836	900	710	1461	2xIM/IR11
iC7-60SAIN05-1710E00	1603	1570	1310	2227	1100	900	1787	2xIM/IR11
iC7-60SAIN05-1760E00	1807	1770	1470	2499	1200	1000	1949	3xIM/IR11
iC7-60SAIN05-1960E00	1940	1900	1580	2686	1300	1100	2112	3xIM/IR11
iC7-60SAIN05-2150E00	2083	2040	1700	2890	1400	1100	2273	3xIM/IR11
iC7-60SAIN05-2340E00	2195	2150	1790	3043	1500	1200	2436	3xIM/IR11
iC7-60SAIN05-2510E00	2389	2340	1950	3315	1600	1300	2598	3xIM/IR11
iC7-60SAIN05-2640E00	2532	2480	2060	3502	1700	1400	2760	4xIM/IR11
iC7-60SAIN05-2880E00	2685	2630	2190	3723	1800	1500	2922	4xIM/IR11
iC7-60SAIN05-3060E00	2828	2770	2300	3910	1900	1500	3085	4xIM/IR11
iC7-60SAIN05-3280E00	3114	3050	2540	4318	2000	1700	3246	4xIM/IR11
iC7-60SAIN05-3420E00	3277	3210	2670	4539	2200	1800	3572	5xIM/IR11
iC7-60SAIN05-3600E00	3573	3500	2910	4947	2400	1900	3897	5xIM/IR11
iC7-60SAIN05-4060E00	3859	3780	3140	5338	2600	2100	4221	5xIM/IR11
iC7-60SAIN05-4320E00	4176	4090	3400	5780	2800	2300	4546	6xIM/IR11
iC7-60SAIN05-4870E00	4625	4530	3760	6392	3100	2600	5033	6xIM/IR11

<sup>1)</sup> Preliminary values subject to validation $I_L$ : Low overload – 110% overload – 1 min every 5 min $I_H$ : High overload – 150% overload – 1 min every 5 min

# AFE modules



## AFE module

The AFE unit is a bi-directional low harmonic supply unit for motor drive applications. Active front end is typically used as a supply to a common DC bus drive line-ups or high power single drives when low harmonics or regeneration of power back to the grid is needed/valued.

The main functionality of the AFE is to maintain stable DC-link voltage reference. The AFE transfers power between the grid and the DC bus both ways depending on the load of the DC bus.

## Benefits of the AFE

- Regenerative energy is fed back to the grid, improving the payback time of the investment. Regeneration at full power is available at any time.
- The AFE can boost the DC-link voltage within the voltage window of the converter hardware. Its advantage is that the DC-voltage available for motor inverters is not limited even under non-ideal grid conditions.

- Power quality is excellent since the grid current is sinusoidal with very low harmonics (<5% THDi) and power factor is unity ( $\cos \varphi = 1$ ). This means that there is no need to oversize incoming supply transformers, as for traditional diode rectifiers, which reduces investment costs and space.

## Ratings

- 317-4900 A  $I_L$ , +10% overload 1 min/5 min
- 380-500 V AC / 465-740 V DC (05)
- 45-66 Hz Grid frequency
- THDi <5%
- Fundamental power factor  $\cos \varphi = 1$ , adjustable reactive current set point

## Highlights

- Most compact AFE on the market
- Meets the most stringent harmonics requirements thanks to high DC and AC power quality
- Robust and reliable in varying ambient conditions
- IP54/Type 12 segregated main cooling channel supporting back-channel cooling solutions
- Designed for enclosure integration and quick serviceability

- Direct connection between LCL filter and AFE input terminals
- Slide-in philosophy for easy power unit and LCL filter installation and removal

## DC-bus and grid control

- Fast primary control ensures stable DC voltage even under non-ideal grid conditions for accurate motor control.
- AFE is able to boost DC voltage to guarantee full motor voltage even when the supply voltage is below nominal.
- Low harmonic operation meets even the strictest power quality requirements for drive systems.
- Reactive reference can be used to compensate other low power factor equipment in the network.
- Unrivalled paralleling options with no need for drive-to-drive communication
- Power can be shared between parallel units automatically with DC-link voltage droop control.

## Active front-end modules (AFE)

## AFE 400 V AC, 465-650 V DC

Model code	AC ratings				DC ratings			Frame
	$S_N$	$I_{N(1/5)}$	$I_{L(1/5)}$	$I_{H(1/5)}$	$I_{N-DC}$	$P_L$	$P_H$	IP00
	[KVA]	[A]	[A]	[A]	[A]	[kW]	[kW]	
iC7-60SA3A05-317AE00	220	324	317	263	371	216	179	AM/AR10
iC7-60SA3A05-400AE00	278	409	400	327	469	272	223	AM/AR10
iC7-60SA3A05-514AE00	357	525	514	426	602	349	290	AM/AR10
iC7-60SA3A05-580AE00	402	593	580	464	677	394	316	AM/AR11
iC7-60SA3A05-650AE00	451	664	650	525	760	442	357	AM/AR11
iC7-60SA3A05-730AE00	506	746	730	591	852	496	402	AM/AR11
iC7-60SA3A05-816AE00	566	833	816	678	953	555	461	AM/AR11
iC7-60SA3A05-920AE00	638	940	920	735	1075	625	500	2xAM/AR10
iC7-60SA3A05-1030E00	714	1052	1030	850	1203	700	578	2xAM/AR10
iC7-60SA3A05-1210E00	839	1236	1210	980	1413	822	666	2xAM/AR11
iC7-60SA3A05-1410E00	977	1440	1410	1140	1647	958	775	2xAM/AR11
iC7-60SA3A05-1630E00	1130	1664	1630	1360	1903	1107	924	2xAM/AR11
iC7-60SA3A05-1860E00	1289	1899	1860	1575	2172	1263	1070	3xAM/AR11
iC7-60SA3A05-2120E00	1469	2165	2120	1838	2475	1440	1248	3xAM/AR11
iC7-60SA3A05-2450E00	1698	2501	2450	2030	2861	1664	1379	3xAM/AR11
iC7-60SA3A05-2800E00	1940	2859	2800	2231	3268	1902	1515	4xAM/AR11
iC7-60SA3A05-3270E00	2266	3338	3270	2710	3817	2221	1840	4xAM/AR11
iC7-60SA3A05-3650E00	2529	3726	3650	2888	4260	2479	1961	5xAM/AR11
iC7-60SA3A05-4080E00	2827	4165	4080	3390	4761	2771	2302	5xAM/AR11
iC7-60SA3A05-4500E00	3118	4594	4500	3544	5251	3056	2407	6xAM/AR11
iC7-60SA3A05-4900E00	3395	5002	4900	4070	5719	3327	2764	6xAM/AR11

$I_L$ : Low overload – 110% overload – 1 min every 5 min

$I_H$ : High overload – 150% overload – 1 min every 5 min

# Active front-end modules (AFE) <sup>1)</sup>

## AFE 480 V AC, 650-740 V DC

Model code	AC ratings				DC ratings			Frame
	$S_N$	$I_{N(1/5)}$	$I_{L(1/5)}$	$I_{H(1/5)}$	$I_{N-DC}$	$P_L$	$P_H$	IP00
	[KVA]	[A]	[A]	[A]	[A]	[kW]	[kW]	
iC7-60SA3A05-317AE00	257	316	309	256	361	252	209	AM/AR10
iC7-60SA3A05-400AE00	316	388	380	298	445	310	243	AM/AR10
iC7-60SA3A05-514AE00	385	473	463	385	542	378	314	AM/AR10
iC7-60SA3A05-580AE00	433	531	520	424	608	424	346	AM/AR11
iC7-60SA3A05-650AE00	487	598	585	470	684	477	383	AM/AR11
iC7-60SA3A05-730AE00	541	664	650	511	759	530	417	AM/AR11
iC7-60SA3A05-816AE00	608	747	731	607	853	596	495	AM/AR11
iC7-60SA3A05-920AE00	686	843	825	639	964	673	521	2xAM/AR10
iC7-60SA3A05-1030E00	774	950	930	770	1086	758	628	2xAM/AR10
iC7-60SA3A05-1150E00	898	1103	1080	880	1262	880	717	2xAM/AR11
iC7-60SA3A05-1280E00	1040	1276	1250	1030	1460	1019	840	2xAM/AR11
iC7-60SA3A05-1630E00	1214	1491	1460	1210	1705	1190	986	2xAM/AR11
iC7-60SA3A05-1860E00	1389	1705	1670	1363	1949	1361	1111	3xAM/AR11
iC7-60SA3A05-2120E00	1588	1950	1910	1533	2230	1557	1250	3xAM/AR11
iC7-60SA3A05-2450E00	1821	2236	2190	1820	2557	1785	1483	3xAM/AR11
iC7-60SA3A05-2800E00	2087	2563	2510	1874	2930	2046	1527	4xAM/AR11
iC7-60SA3A05-3270E00	2428	2981	2920	2430	3408	2380	1980	4xAM/AR11
iC7-60SA3A05-3650E00	2736	3359	3290	2726	3840	2681	2222	5xAM/AR11
iC7-60SA3A05-4080E00	3035	3726	3650	3030	4260	2974	2469	5xAM/AR11
iC7-60SA3A05-4500E00	3334	4094	4010	3152	4681	3268	2569	6xAM/AR11
iC7-60SA3A05-4900E00	3650	4482	4390	3640	5124	3577	2966	6xAM/AR11

<sup>1)</sup> Preliminary values subject to validation

$I_L$ : Low overload – 110% overload – 1 min every 5 min  
 $I_H$ : High overload – 150% overload – 1 min every 5 min



Active front-end modules (AFE) <sup>1)</sup>

## AFE, 500 V AC, 650-740 V DC

Model code	AC ratings				DC ratings			Frame
	$S_N$	$I_{N(1/5)}$	$I_{L(1/5)}$	$I_{H(1/5)}$	$I_{N-DC}$	$P_L$	$P_H$	IP00
	[KVA]	[A]	[A]	[A]	[A]	[kW]	[kW]	
iC7-60SA3A05-317AE00	268	316	309	256	361	263	218	AM/AR10
iC7-60SA3A05-400AE00	330	388	380	298	445	323	253	AM/AR10
iC7-60SA3A05-514AE00	401	473	463	385	542	393	327	AM/AR10
iC7-60SA3A05-580AE00	451	531	520	424	608	442	360	AM/AR11
iC7-60SA3A05-650AE00	507	598	585	470	683	497	399	AM/AR11
iC7-60SA3A05-730AE00	563	664	650	511	760	552	434	AM/AR11
iC7-60SA3A05-816AE00	634	747	731	607	854	621	516	AM/AR11
iC7-60SA3A05-920AE00	715	843	825	639	963	701	543	2xAM/AR10
iC7-60SA3A05-1030E00	806	950	930	770	1086	790	654	2xAM/AR10
iC7-60SA3A05-1150E00	936	1103	1080	880	1261	917	747	2xAM/AR11
iC7-60SA3A05-1280E00	1083	1276	1250	1030	1459	1061	875	2xAM/AR11
iC7-60SA3A05-1630E00	1265	1491	1460	1210	1704	1240	1027	2xAM/AR11
iC7-60SA3A05-1860E00	1447	1705	1670	1363	1949	1418	1157	3xAM/AR11
iC7-60SA3A05-2120E00	1655	1950	1910	1533	2229	1622	1302	3xAM/AR11
iC7-60SA3A05-2450E00	1897	2236	2190	1820	2557	1859	1545	3xAM/AR11
iC7-60SA3A05-2800E00	2174	2563	2510	1874	2930	2131	1591	4xAM/AR11
iC7-60SA3A05-3270E00	2529	2981	2920	2430	3408	2479	2063	4xAM/AR11
iC7-60SA3A05-3650E00	2850	3359	3290	2726	3840	2793	2314	5xAM/AR11
iC7-60SA3A05-4080E00	3161	3726	3650	3030	4260	3098	2572	5xAM/AR11
iC7-60SA3A05-4500E00	3473	4094	4010	3152	4681	3404	2676	6xAM/AR11
iC7-60SA3A05-4900E00	3802	4482	4390	3640	5124	3726	3090	6xAM/AR11

<sup>1)</sup> Preliminary values subject to validation

$I_L$ : Low overload – 110% overload – 1 min every 5 min  
 $I_H$ : High overload – 150% overload – 1 min every 5 min

## Dimensions and weight <sup>1)</sup>: INU and AFE modules, LCL filters

Module type		Inverter		AFE		LCL filters
Frame		IM10	IM11	AM10	AM11	LCL10/LCL11
[mm]	Width	170	210	170	210	260
	Height	990	990	990	990	1530
	Depth	502	502	502	502	553
[kg]	Weight	65	75	65	75	-
[in]	Width	6.7	8.3	6.7	8.3	10.2
	Height	39	39	39	39	60.2
	Depth	19.8	19.8	19.8	19.8	21.8
[lb]	Weight	143	165	143	165	-

<sup>1)</sup> Preliminary values subject to validation  
 For more information refer to the iC7-60 Air-cooled System Modules Operating Guide

## Dimensions and weight <sup>2)</sup>: INU, AFE and NFE modules with short integration unit

Module type		Inverter with integration unit		AFE with integration unit		NFE with integration unit
Frame		IR10	IR11	AR10	AR11	NR11
[mm]	Width	235	235	235	235	235
	Height	1302	1302	921	921	921
	Depth	553	553	553	553	553
[kg]	Weight	90	100	72	82	-
[in]	Width	9.3	9.3	9.3	9.3	9.3
	Height	51.3	51.3	36.3	36.3	36.3
	Depth	21.8	21.8	21.8	21.8	21.8
[lb]	Weight	198	221	159	181	-

<sup>2)</sup> Preliminary values subject to validation  
 Weight values are for module with empty integration unit, excluding filter weight.  
 For more information refer to the iC7-60 Air-cooled System Modules Operating Guide



Module with no integration unit

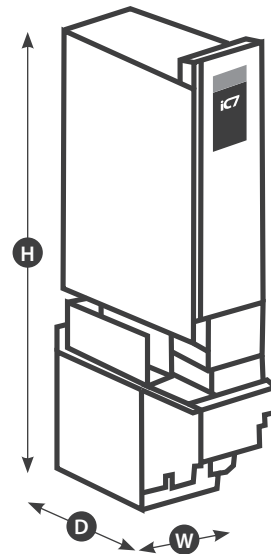
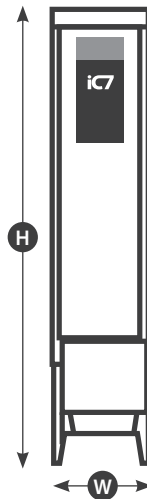

Module with short integration unit

## Dimensions and weight <sup>2)</sup>: INU and AFE modules with standard integration unit

Module type		Inverter with integration unit		AFE with integration unit	
Frame		IR10	IR11	AR10	AR11
[mm]	Width	235	235	235	235
	Height	1530	1530	1530	1530
	Depth	553	553	553	553
[kg]	Weight	92	102	78	88
[in]	Width	9.3	9.3	9.3	9.3
	Height	60.2	60.2	60.2	60.2
	Depth	21.8	21.8	21.8	21.8
[lb]	Weight	202.8	224.9	172	194

<sup>2)</sup> Preliminary values subject to validation

Weight values are for module with empty integration unit, excluding filter weight.

For more information refer to the iC7-60 Air-cooled System Modules Operating Guide

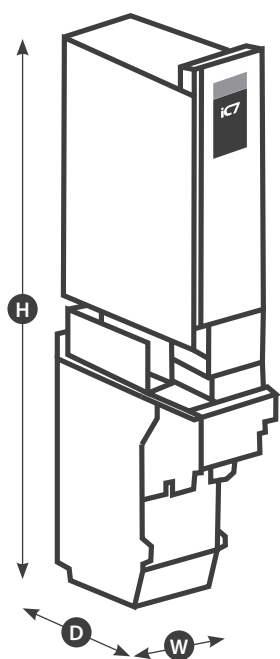

Module with standard integration unit

# Liquid-cooled System Modules

## Need flexible integration with extraordinary power density?

Optimize installation footprint, speed and reduce costs more than you dreamt possible, with the revolutionary iC7 series liquid-cooled system modules with integration unit.

High power density thanks to new filter technology means you achieve a smaller footprint and reduce space requirements in your electrical room. Filters integrate beneath the module, so you don't need extra cabinet space for them.

Enjoy optimal cabinet integration, with input and output filters contained within the pre-wired integration unit. Mechanical integration is fast with unified mechanical interfaces and modular design.

Meet weight restrictions more easily with iC7 liquid-cooled system modules, which are amazingly lightweight compared to standard solutions on the market.

Power density is optimized for a universal 600 mm depth cabinet. Install multiple units in parallel to achieve power range up to 6 MW, with no need for an output filter. Service is faster with lightweight power units; and with quick coolant connectors, there is no need to drain the cooling system.

Reduce your operating costs with industry-benchmark liquid cooling. These modules offer true liquid cooling technology with very low losses to air. There's no need to spend time on connections, since cooling distribution to filters and system modules is built-in.

## Robust in harsh environments

The combined vibration, temperature, humidity, and moisture/dust resistance with IP55 electronics compartment, ensures more reliable operation than most alternative drives. Run at 60 °C with no derating.

Achieve flexibility with our highly expandable filter concept. Select your choice of input and output filter options in the integration unit located beneath the module. The same mechanical concept serves all module variants: INU, AFE, GC, and DC/DC.

## HIGHLIGHTS

- **Save space with world-class power density**
- **Market leading weight savings makes it ideal for light weight installations**
- **Reliable even in harsh conditions**
- **Fast mechanical integration**
- **Fast and easy service**
- **Close to silent operation**
- **World-first drive with cyber-secure design**
- **More uptime, longer service intervals and long storage life due to film capacitor technology**
- **Liquid cooling enables reuse of waste heat for energy efficiency**



Pack in more  
**power**



# Features and benefits – all liquid-cooled system modules

Feature	Benefit
Market-leading power density	Save space and weight in marine and urban installations
World's most reliable drive Robust thanks to high quality design: vibration- and shock-resistant aluminium frame with IP55 protected electronics compartment	High uptime Peace of mind even in unpredictable conditions
Output filters and fuses integrate neatly below the power module	Reduced footprint. Reduced cost of integration and service
Performs reliably at high ambient and coolant temperatures	High uptime in harsh environments
Quick connectors, no draining of liquid, quick cabling	Fast serviceability
Cloud connectivity is cybersecure	Reduced risk of unauthorized access or cybersecurity incident
Same mechanical integration for all applications (INU, AFE, GC, DC/DC) means fewer variants are required	Reduce storage required for spares and complexity in integration Simplify serviceability
Modular and scalable. Fewer variants. No need for output filters when installing modules in parallel.	Reduce cost of integration Go to market faster Simplify serviceability
Long design life and film capacitor technology	Reduced maintenance downtime
True liquid cooling ensures low losses to air and enables reuse of waste heat for energy efficiency	Highest possible system efficiency Reduced air conditioning need
DNV, ABS, LR <sup>1)</sup> , BV, CCS, KR <sup>1)</sup> and NK <sup>1)</sup> certifications, including type approvals for the system module and filters in the integration unit	Accelerate certification time for marine systems

<sup>1)</sup> Certification pending

## Liquid-cooled module types

**Control unit and control options**

**System modules**  
AM/IM/DM10L modules

**System modules**  
AM/IM/DM12L modules

**Inverter unit**  
IR10L with or without filters

**Inverter unit**  
IR12L with or without filters

**AFE & GC**  
AR10L with LC-filter

**AFE & GC**  
AR12L with LC-filter



**DC/DC Converter**  
DR10L  
With DC/DC filter

**DC/DC Converter**  
DR12L  
With DC/DC filter

System module(s) for integration unit

Integration unit: contains options "+AE\_" input or output filter

Example AFE module with LC-filter

Enclosure solution example



1.8 MVA  
Grid Converter  
or AFE with  
LC filter in  
600 mm wide  
enclosure

Illustrations not to scale

## Highly compact cooling unit

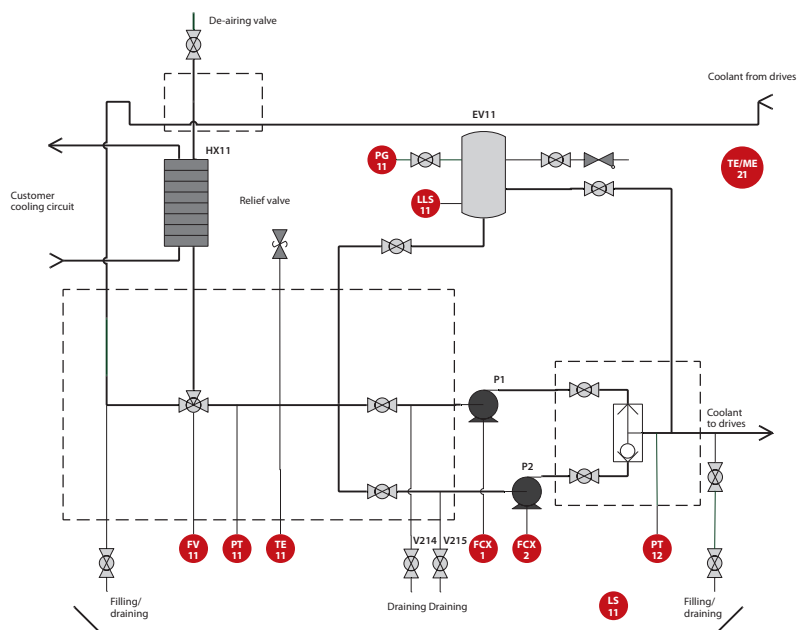

The iC7 series liquid-cooled system modules empower you to pack a lot of power into a small space, to optimize your systems – and give you new application opportunities. At the heart of this groundbreaking technology is the cooling unit.

The cooling unit is service-friendly despite its extremely compact design, making it fast and easy to work with.

The cooling unit gives you especially easy access to the pump, as well as providing pump shut-off valves.

### What's included in the cooling unit

- Liquid cooling temperature control with integrated 3-way valve
- Extensive sensor package with humidity and ambient temperature measurement

### Compatibility

- Compatible with diverse Ethernet-based fieldbuses

### Type approvals (pending)

- DNV, ABS, LR, BV and CCS

## Technical information

### System pressure

- Customer side: max 1000 kPa
- Drive side working pressure: 50-350 kPa, maximum 600 kPa

### Cooling

- Ambient temperature: -15-55 °C
- Coolant temperature: -15-38 °C (lth) (nominal); 38-55 °C with limited performance

- Cooling unit supply distance: 15-25 m, optionally up to 40 m
- Drive-side temperature control with 3-way valve and actuator

### Sensor measurements on the drive side

- Pressure
- Flow (pressure sensor-based)
- Temperature

- Leakage detection
- Condensation (humidity/ambient temperature sensor-based.)

### Optional extras

- Enclosure IP23 (without enclosure) and IP54
- Double/redundant pump
- Coolant connectors positioned on left or right side of the cooling unit

Cooling unit					
Model code	Cooling power [kW]	Coolant flow [l/min]	Pump quantity	Dimensions IP23 enclosures W x H x D [mm]	Dimensions IP54 enclosures W x H x D [mm]
iC7-60SLQxx-0076...	76	190	1 and 2	300/500 x 1900 x 550	408/608 x 2060 x 608
iC7-60SLQxx-0152...	152	360	1 and 2	300/500 x 1900 x 550	408/608 x 2060 x 608

## Key specifications

Mains connection (AFE & GC)	
Mains voltage $U_{in}$	<ul style="list-style-type: none"> <li>– Voltage class 07: 3 x 525-690 V AC (-15% – +10%); 640-1100 VDC (-0% – +0%)</li> <li>– Voltage class B5: 3 x 380-500 V AC (-15%...+10%); 465-800 V DC (-0%...+0%)</li> </ul>
Mains frequency	– 45-66 Hz AFE, GC, 25-70 Hz for GC with derating
Supply network	<ul style="list-style-type: none"> <li>– TN-S, TN-C, IT and TT</li> <li>– Supply voltage limited to 500 V AC for corner grounded networks</li> </ul>
Power factor	<ul style="list-style-type: none"> <li>– <math>\cos\phi = 1</math>: (fundamental) (AFE module)</li> <li>– <math>\cos\phi = 1</math> leading to 1 lagging (fundamental) (GC module)</li> </ul>
Short circuit current	– Maximum short circuit current must be < 100 kA
Total harmonics distortion THDi	– < 5%: (AFE and GC module), < 3% with dedicated transforme
Overvoltage category	– Class III according to IEC/EN 61800-5-1
Imbalance	<ul style="list-style-type: none"> <li>– Nominal performance with voltage imbalance <math>\leq 3\%</math>. (AFE and GC module)</li> <li>– Limited performance with &gt;3% voltage imbalance</li> </ul>
Connections to mains	– Once every 120 s
Motor connection (INU)	
Output voltage	– $0-U_{in}$ , 3-phase
Output frequency	– 0-599 Hz ( <i>Limited performance with output filters above 70 Hz</i> )
Switching frequency	– 1.5-10 kHz (525-690 V AC) Default switching frequency 3 kHz
Motor control principles	<ul style="list-style-type: none"> <li>– U/f control</li> <li>– Voltage Vector Control (VVC+)</li> <li>– Flux Vector Control (FVC+)</li> </ul>
Motor and generator types supported	<ul style="list-style-type: none"> <li>– Induction/asynchronous motor</li> <li>– Permanent magnet motor</li> <li>– Salient permanent magnet motor</li> <li>– Synchronous reluctance assisted permanent magnet motor</li> </ul>
Cable length	– Up to 150 m [492 feet] with symmetrical 3-phase screened motor cable
DC connection (DC/DC converter)	
DC bus voltage	<ul style="list-style-type: none"> <li>– Voltage class 07: 640-1100 VDC (-0%..+0%)</li> <li>– Voltage class B5: 465-800 V DC (-0%..+0%)</li> </ul>
DC source voltage	<ul style="list-style-type: none"> <li>– 3%-100% of DC bus voltage</li> <li>– 3%-97% of DC bus voltage with full control performance</li> </ul>
Source current ripple with iC7 DC/DC Filters	<ul style="list-style-type: none"> <li>– DR10L &lt; 1% RMS (typical)</li> <li>– DR12L &lt; 0.5% RMS (typical)</li> </ul>
EMC (IEC61800-3)	
Immunity	– Fulfils IEC/EN61800-3 (2018), 2nd environment
Emissions	<ul style="list-style-type: none"> <li>– IEC/EN61800-3 (2018), category C4, default for the IP00/UL Open Type drive</li> <li>– IEC/EN61800-3 (2018), category C3, if the drive is installed according to the instructions of the manufacturer (<i>C3 not applicable for DC/DC Converter</i>)</li> </ul>



Liquid cooling	
Temperature of cooling agent	<ul style="list-style-type: none"> <li>-10 to +45°C (<math>I_N</math>)(nominal), up to 60 C with derating</li> <li>Temperature rise during circulation max 10°C</li> <li>Glycol to be used in cooling agent below 0°C and ice formation not permitted</li> </ul>
System max. working pressure	<ul style="list-style-type: none"> <li>Operating pressure 100-150 kPa (recommended)</li> <li>Maximum pressure 500 kPa</li> </ul>
Pressure drop	– 50-120 kPa at rated volumetric flow.
Allowed cooling agents	– Demineralized water or good pure quality water according to cooling liquid quality specification with inhibitor and propylene or ethylene glycol
Corrosion inhibitor	– Corrosion inhibitor recommended, for long lifetime
Allowed materials in the cooling system	<ul style="list-style-type: none"> <li>Aluminum</li> <li>Stainless steel AISI 304/316</li> <li>Plastic (PVC not allowed)</li> <li>Elastomers (EPDM, NBR, FDM)</li> </ul>

Environmental conditions	
Protection rating drive modules	– IP00/UL Open Type
Ambient operating temperature	– -15°C (no frost) to +60°C (at $I_N$ )
Storage/transportation temperature	– -40°C to +70°C; glycol to be used in liquid under 0°C and ice formation not permitted
Relative humidity	– 5 to 96% RH, no dripping water or condensation allowed
Pollution degree	– PD3
Altitude	<ul style="list-style-type: none"> <li>0-3000 m above sea level: voltage class 07 without AFE supply</li> <li>0-2000 m: voltage class 07 with AFE supply</li> <li>Above 1,000 m derating of maximum ambient operating temperature by 0.5 °C per each 100 m is required</li> </ul>
Vibration (IEC60068-2-6)	<ul style="list-style-type: none"> <li>Displacement amplitude 1 mm (peak) at 2-13.2 Hz</li> <li>Maximum acceleration amplitude 0.7 G at 13.2-100 Hz with maximum amplification of 5</li> </ul>
Shock (IEC60068-2-27)	– Max 15G, 11 ms ( <i>in package</i> )
Environmental operating conditions (IEC 60721-3-3)	<ul style="list-style-type: none"> <li>Climatic conditions: Class 3K22</li> <li>Chemically active substances: IEC 60721-3-3 Edition 3.0/ISO 3223 Second Edition, class C4</li> <li>Biological conditions: Class 3B1</li> <li>Mechanically active substances: Class 3S6</li> <li>Special climatic conditions (heat radiation): Class 3Z1</li> </ul>

Run at

**60°C**

with no derating



## INU modules



### Inverter module (INU)

The inverter module is a bidirectional DC-fed power inverter for the supply and control of AC motors and generators.

The inverter (INU) module is intended for the regulation of motor speed in response to system feedback or to remote commands from external controllers. A drive system consists of the system modules, the motor, and equipment driven by the motor. The INU module is also intended for system and motor status surveillance.

### Benefits of the Inverter module

- Designed for maximum machine performance and flexibility
- Versatility for drive applications requiring a wide range of drive features for different motor types for either closed loop or open loop control methods

- Optional system module with integration unit including high performance dU/dt filters and/or common-mode filters as well as sine wave filter for space saving

### Ratings at 45°C coolant and 60°C ambient temperature

- 170-6400 A IL, +10% overload 1 min/5 min
- 525-690 V AC / 640-1100 V DC (07)
- 380-500 V AC / 465-800 V DC (B5)
- Output frequency: 0-599 Hz
- Switching frequency: 2-10 kHz. Nominal 3 kHz

### Highlights

- Most compact INU module on the market thanks to integration of filters
- Robust and reliable in varying ambient conditions
- Designed for enclosure integration and quick serviceability

### Motor control

- Highly dynamic performance: Highest possible machine accuracy due to superior shaft performance, also for sensorless operation
- Superior low-speed performance also in sensorless operation
- The motor always runs at maximum possible torque for the given current – ensuring highest possible motor efficiency: Maximum Torque Per Ampere (MTPA)
- Fast commissioning using Automatic Motor Adaption (AMA) at standstill maximizes energy efficiency with any motor
- More integrated sensors for better performance
- Flexible choice of control features optimized to your application, thanks to integrated application software
- Variable speed power generation with stable DC voltage reference even without filter

# Inverter unit (INU) ratings at 500 V AC

## iC7-60SLINB5, 380-500 V AC (465-800 VDC), IP00 Liquid-Cooled Inverter Unit

Model code	AC ratings <sup>1)</sup>				Motor output power <sup>2)</sup>		Frame	Frame with option +AE__
	3 x 380-500 V				500 V AC mains			
	$I_N$	$I_L$	$I_H$	$I_{peak}$	$P_L$	$P_H$		
	[A]	[A]	[A]	[A]	[kW]	[kW]		
iC7-60SLINB5-206AE00F4	211	206	155	310	132	90	IM10L	IR10L
iC7-60SLINB5-245AE00F4	251	245	184	368	160	110	IM10L	IR10L
iC7-60SLINB5-302AE00F4	309	302	227	454	200	132	IM10L	IR10L
iC7-60SLINB5-385AE00F4	394	385	289	578	250	160	IM10L	IR10L
iC7-60SLINB5-416AE00F4	425	416	312	624	270	200	IM10L	IR10L
iC7-60SLINB5-525AE00F4	536	525	393	786	355	250	IM12L	IR12L
iC7-60SLINB5-590AE00F4	603	590	442	884	400	250	IM12L	IR12L
iC7-60SLINB5-650AE00F4	672	650	487	974	400	315	IM12L	IR12L
iC7-60SLINB5-730AE00F4	746	730	547	1094	500	355	IM12L	IR12L
iC7-60SLINB5-820AE00F4	838	820	615	1230	560	400	IM12L	IR12L
iC7-60SLINB5-1060AE00F4	1083	1060	795	1590	630	500	2xIM12L	2xIR12L
iC7-60SLINB5-1230AE00F4	1256	1230	922	1844	800	630	2xIM12L	2xIR12L
iC7-60SLINB5-1400AE00F4	1430	1400	1050	2100	900	710	2xIM12L	2xIR12L
iC7-60SLINB5-1500AE00F4	1532	1500	1125	2250	1000	710	2xIM12L	2xIR12L
iC7-60SLINB5-1640AE00F4	1675	1640	1230	2460	1100	800	2xIM12L	2xIR12L
iC7-60SLINB5-1795AE00F4	1833	1795	1346	2692	1200	900	3xIM12L	3xIR12L
iC7-60SLINB5-2080AE00F4	2124	2080	1560	3120	1400	1000	3xIM12L	3xIR12L
iC7-60SLINB5-2300AE00F4	2348	2300	1725	3450	1500	1100	3xIM12L	3xIR12L
iC7-60SLINB5-2500AE00F4	2552	2500	1875	3750	1700	1200	3xIM12L	3xIR12L
iC7-60SLINB5-2830AE00F4	2889	2830	2122	4244	2600	1950	4xIM12L	4xIR12L
iC7-60SLINB5-3050AE00F4	3114	3050	2287	4574	2800	2000	4xIM12L	4xIR12L
iC7-60SLINB5-3260AE00F4	3328	3260	2445	4890	3000	2200	4xIM12L	4xIR12L

<sup>1)</sup> **Ratings are valid at 800V nominal DC voltage**

$I_N$  Nominal (thermal) continuous current. Dimensioning can be done according to this current if the process does not require any overloadability or the process does not include any load variation or margin for overloadability

$I_L$  Low overload – 110% overload – 1 min every 5 min

$I_H$  High overload – 150% overload – 1 min every 5 min

$I_{peak}$  Peak output current. Available for 3 seconds at start, then as long as allowed by system module temperature

<sup>2)</sup> All values with efficiency = 98.5%



# Inverter unit (INU) ratings at 690 V AC

## iC7-60SLIN07, 525-690 V AC (640-1100 V DC), Type Open/IP00 inverter unit

Model code	AC ratings <sup>1)</sup>				Motor output power <sup>2)</sup>		Frame	Frame with option +AE__
	3 x 525-690 V				690 V AC mains			
	$I_N$	$I_L$	$I_H$	$I_{peak}$	$P_L$	$P_H$		
[A]	[A]	[A]	[A]	[kW]	[kW]			
iC7-60SLIN07-170AE00F4	175	170	127	254	160	90	IM10L	IR10L
iC7-60SLIN07-208AE00F4	215	208	156	312	200	132	IM10L	IR10L
iC7-60SLIN07-261AE00F4	270	261	195	390	250	160	IM10L	IR10L
iC7-60SLIN07-325AE00F4	335	325	243	486	315	200	IM10L	IR10L
iC7-60SLIN07-365AE00F4	375	365	273	546	355	250	IM10L	IR10L
iC7-60SLIN07-416AE00F4	425	416	312	624	400	250	IM10L	IR10L
iC7-60SLIN07-465AE00F4	475	465	348	696	450	315	IM12L	IR12L
iC7-60SLIN07-525AE00F4	535	525	393	786	500	355	IM12L	IR12L
iC7-60SLIN07-590AE00F4	605	590	442	884	560	400	IM12L	IR12L
iC7-60SLIN07-650AE00F4	665	650	487	974	630	450	IM12L	IR12L
iC7-60SLIN07-730AE00F4	745	730	547	1094	710	500	IM12L	IR12L
iC7-60SLIN07-820AE00F4	840	820	615	1230	800	560	IM12L	IR12L
iC7-60SLIN07-945AE00F4	965	945	708	1416	900	630	2xIM12L	2xIR12L
iC7-60SLIN07-1060E00F4	1090	1060	795	1590	1000	710	2xIM12L	2xIR12L
iC7-60SLIN07-1230E00F4	1260	1230	922	1844	1100	800	2xIM12L	2xIR12L
iC7-60SLIN07-1400E00F4	1430	1400	1050	2100	1300	900	2xIM12L	2xIR12L
iC7-60SLIN07-1500E00F4	1540	1500	1125	2250	1400	1000	2xIM12L	2xIR12L
iC7-60SLIN07-1640E00F4	1680	1640	1230	2460	1500	1100	2xIM12L	2xIR12L
iC7-60SLIN07-1795E00F4	1840	1795	1346	2692	1700	1250	3xIM12L	3xIR12L
iC7-60SLIN07-2080E00F4	2130	2080	1560	3120	1900	1400	3xIM12L	3xIR12L
iC7-60SLIN07-2300E00F4	2350	2300	1725	3450	2100	1600	3xIM12L	3xIR12L
iC7-60SLIN07-2500E00F4	2560	2500	1875	3750	2300	1750	3xIM12L	3xIR12L
iC7-60SLIN07-2830E00F4	2890	2830	2122	4244	2600	1950	4xIM12L	4xIR12L
iC7-60SLIN07-3050E00F4	3120	3050	2287	4574	2800	2000	4xIM12L	4xIR12L
iC7-60SLIN07-3260E00F4	3330	3260	2445	4890	3000	2200	4xIM12L	4xIR12L
iC7-60SLIN07-3500E00F4	3580	3500	2625	5250	3300	2400	5xIM12L	5xIR12L
iC7-60SLIN07-4035E00F4	4120	4035	3026	6052	3800	2800	5xIM12L	5xIR12L
iC7-60SLIN07-4400E00F4	4500	4400	3300	6600	4100	3100	6xIM12L	6xIR12L
iC7-60SLIN07-4850E00F4	4960	4850	3637	7274	4500	3500	6xIM12L	6xIR12L
iC7-60SLIN07-5300E00F4	5410	5300	3975	7950	5000	3700	7xIM12L	7xIR12L
iC7-60SLIN07-5600E00F4	5720	5600	4200	8400	5300	4000	7xIM12L	7xIR12L
iC7-60SLIN07-6100E00F4	6230	6100	4575	9150	5700	4300	8xIM12L	8xIR12L
iC7-60SLIN07-6400E00F4	6540	6400	4800	9600	6000	4600	8xIM12L	8xIR12L

### <sup>1)</sup> Ratings are valid at 1025 V nominal DC voltage

$I_N$  Nominal (thermal) continuous current. Dimensioning can be done according to this current if the process does not require any overloadability or the process does not include any load variation or margin for overloadability

$I_L$  Low overload – 110% overload – 1 min every 5 min

$I_H$  High overload – 150% overload – 1 min every 5 min

$I_{peak}$  Peak output current. Available for 3 seconds at start, then as long as allowed by system module temperature

<sup>2)</sup> All values with efficiency = 98.5%



## AFE modules



### AFE module

The AFE unit is a bi-directional low harmonic supply unit for motor drive applications. Active front end is typically used as a supply to a common DC bus drive line-ups or single drives when low harmonics or regeneration of power back to the grid is needed/valued.

The main functionality of the AFE is to maintain stable DC-link voltage reference. The AFE transfers power between the grid and the DC bus both ways depending on the load of the DC bus.

### Benefits of the AFE

- Regenerative energy is fed back to the grid, improving the payback time of the investment. Regeneration at full power is available at any time.
- The AFE can boost the DC-link voltage within the voltage window of the converter hardware. Its advantage is that the DC-voltage available for motor inverters is not limited even under non-ideal grid conditions.

- Power quality is excellent since the grid current is sinusoidal with very low harmonics (<5% THDi) and power factor is unity ( $\cos \varphi = 1$ ) This means that there is no need to oversize incoming supply transformers, as for traditional diode rectifiers, which reduces investment costs and space.

### Ratings

- 236-5750 A  $I_L$ , +10% overload 1 min/5 min
- 525-690 V AC / 640-1100 V DC (07)
- 380-500 V AC / 465-800 V DC (B5)
- 45-66 Hz Grid frequency
- THDi <5%
- Fundamental power factor  $\cos \varphi = 1$ , adjustable reactive current set point
- Ambient temperature 60 °C at  $I_N$
- Coolant temperature 45 °C at  $I_N$ , with the exception of 38 °C at  $I_N$  for current ratings 380 A, 760 A, 1500 A, 2250 A, 2940 A, 3600 A, 4320 A, 5040 A, 5750 A.

### Highlights

- Most compact AFE on the market thanks to integration of LC-filter and fuses
- Meets the most stringent harmonics requirements thanks to high DC and AC power quality

- Robust and reliable in varying ambient conditions
- Designed for enclosure integration and quick serviceability
- Lowest weight on the market thanks to new filter technology

### DC-bus and grid control

- Fast primary control ensures stable DC voltage even under non-ideal grid conditions for accurate motor control.
- AFE is able to boost DC voltage to guarantee full motor voltage even when the supply voltage is below nominal.
- Low harmonic operation meets even the strictest power quality requirements for drive systems.
- Reactive reference can be used to compensate other low power factor equipment in the network.
- Unrivalled paralleling options with no need for drive-to-drive communication
- Power can be shared between parallel units automatically with DC-link voltage droop control.

# Active front-end (AFE) ratings at 690 V AC

## iC7-60SL3A07, 525-690 V AC (640-1100 V DC), Type Open / IP00 active front-end

Product code	AC current			DC power <sup>2)</sup>		Frame size	Frame with option +AEZ1 or +AEZ3 <sup>3)</sup>	L-filter size (part of LCL-filter +AEZ3 <sup>3)</sup> )
	Current ratings <sup>1)</sup>			690 V AC mains				
	I <sub>N</sub> [A]	I <sub>L</sub> [A]	I <sub>H</sub> [A]	P <sub>L</sub> [kW]	P <sub>H</sub> [kW]			
iC7-60SL3A07-236AE00F4	241	236	177	277	208	AM10L	AR10L	OF7Z5-M-LC-07-400A-A1-E00-F4
iC7-60SL3A07-300AE00F4	307	300	225	352	264	AM10L	AR10L	OF7Z5-M-LC-07-400A-A1-E00-F4
iC7-60SL3A07-334AE00F4	341	334	250	392	293	AM10L	AR10L	OF7Z5-M-LC-07-400A-A1-E00-F4
iC7-60SL3A07-380AE00F4	388	380	285	446	334	AM10L	AR10L	OF7Z5-M-LC-07-400A-A1-E00-F4
iC7-60SL3A07-425AE00F4	434	425	318	498	373	AM12L	AR12L	OF7Z5-M-LC-07-1000-A1-E00-F4
iC7-60SL3A07-475AE00F4	485	475	356	557	417	AM12L	AR12L	OF7Z5-M-LC-07-1000-A1-E00-F4
iC7-60SL3A07-530AE00F4	542	530	397	621	465	AM12L	AR12L	OF7Z5-M-LC-07-1000-A1-E00-F4
iC7-60SL3A07-595AE00F4	608	595	446	697	523	AM12L	AR12L	OF7Z5-M-LC-07-1000-A1-E00-F4
iC7-60SL3A07-670AE00F4	684	670	502	785	588	AM12L	AR12L	OF7Z5-M-LC-07-1000-A1-E00-F4
iC7-60SL3A07-760AE00F4	776	760	570	891	668	AM12L	AR12L	OF7Z5-M-LC-07-1000-A1-E00-F4
iC7-60SL3A07-850AE00F4	868	850	637	996	747	2xAM12L	2xAR12L	OF7Z5-M-LC-07-1640-A1-E00-F4
iC7-60SL3A07-945AE00F4	965	945	708	1107	830	2xAM12L	2xAR12L	OF7Z5-M-LC-07-1640-A1-E00-F4
iC7-60SL3A07-1040E00F4	1062	1040	780	1219	914	2xAM12L	2xAR12L	OF7Z5-M-LC-07-1640-A1-E00-F4
iC7-60SL3A07-1230E00F4	1256	1230	922	1441	1080	2xAM12L	2xAR12L	OF7Z5-M-LC-07-1640-A1-E00-F4
iC7-60SL3A07-1325E00F4	1353	1325	993	1552	1164	2xAM12L	2xAR12L	OF7Z5-M-LC-07-1640-A1-E00-F4
iC7-60SL3A07-1500E00F4	1532	1500	1125	1757	1318	2xAM12L	2xAR12L	OF7Z5-M-LC-07-1640-A1-E00-F4
iC7-60SL3A07-1700E00F4	1736	1700	1275	1992	1494	3xAM12L	3xAR12L	2xOF7Z5-M-LC-07-1640-A1-E00-F4
iC7-60SL3A07-1800E00F4	1838	1800	1350	2109	1582	3xAM12L	3xAR12L	2xOF7Z5-M-LC-07-1640-A1-E00-F4
iC7-60SL3A07-2000E00F4	2042	2000	1500	2343	1757	3xAM12L	3xAR12L	2xOF7Z5-M-LC-07-1640-A1-E00-F4
iC7-60SL3A07-2250E00F4	2297	2250	1687	2636	1976	3xAM12L	3xAR12L	2xOF7Z5-M-LC-07-1640-A1-E00-F4
iC7-60SL3A07-2500E00F4	2552	2500	1875	2929	2197	4xAM12L	4xAR12L	2xOF7Z5-M-LC-07-1640-A1-E00-F4
iC7-60SL3A07-2650E00F4	2706	2650	1987	3104	2328	4xAM12L	4xAR12L	2xOF7Z5-M-LC-07-1640-A1-E00-F4
iC7-60SL3A07-2940E00F4	3002	2940	2205	3444	2583	4xAM12L	4xAR12L	2xOF7Z5-M-LC-07-1640-A1-E00-F4
iC7-60SL3A07-3120E00F4	3185	3120	2340	3655	2741	5xAM12L	5xAR12L	3xOF7Z5-M-LC-07-1640-A1-E00-F4
iC7-60SL3A07-3600E00F4	3675	3600	2700	4217	3163	5xAM12L	5xAR12L	3xOF7Z5-M-LC-07-1640-A1-E00-F4
iC7-60SL3A07-3900E00F4	3982	3900	2925	4568	3426	6xAM12L	6xAR12L	3xOF7Z5-M-LC-07-1640-A1-E00-F4
iC7-60SL3A07-4320E00F4	4410	4320	3240	5060	3795	6xAM12L	6xAR12L	3xOF7Z5-M-LC-07-1640-A1-E00-F4
iC7-60SL3A07-4750E00F4	4849	4750	3562	5564	4172	7xAM12L	7xAR12L	4xOF7Z5-M-LC-07-1640-A1-E00-F4
iC7-60SL3A07-5040E00F4	5145	5040	3780	5903	4428	7xAM12L	7xAR12L	4xOF7Z5-M-LC-07-1640-A1-E00-F4
iC7-60SL3A07-5400E00F4	5513	5400	4050	6325	4744	8xAM12L	8xAR12L	4xOF7Z5-M-LC-07-1640-A1-E00-F4
iC7-60SL3A07-5750E00F4	5870	5750	4312	6735	5051	8xAM12L	8xAR12L	4xOF7Z5-M-LC-07-1640-A1-E00-F4

<sup>1)</sup> Ratings are valid at 1025V nominal DC voltage

I<sub>N</sub> Nominal (thermal) continuous current. Dimensioning can be done according to this current if the process does not require any overloadability  
 I<sub>L</sub> Low overloadability current (1/5min) Allows +10% load variation for 1 minute every 5 minutes.  
 I<sub>H</sub> High overloadability current (1/5min) Allows +50% load variation for 1 minute every 5 minutes.

<sup>2)</sup> All values with cosφ = 1.00, efficiency = 98.0% and rated voltage 1025 VDC

<sup>3)</sup> Includes LC-filter with the option +AEZ1 and LCL-filter with the option +AEZ3 net side L-filter separate module



## Active front-end (AFE) ratings at 500 V AC

iC7-60SL3AB5, 380-500 V AC (465-800 V DC), Type Open/IP00 active front end<sup>1)</sup>

Product code	AC current			DC power <sup>3)</sup>		Frame size	Frame with option +AEZ1 or +AEZ3 <sup>4)</sup>	L-filter size (part of LCL-filter +AEZ3 <sup>4)</sup> )
	Current ratings <sup>2)</sup>			500 V AC mains				
	I <sub>N</sub> [A]	I <sub>L</sub> [A]	I <sub>H</sub> [A]	P <sub>L</sub> [kW]	P <sub>H</sub> [kW]			
iC7-60SL3AB5-261AE00F4	267	261	196	222	167	AM10L	AR10L	OF7Z5-M-LC-07-400A-A1-E00-F4
iC7-60SL3AB5-325AE00F4	332	325	244	276	208	AM10L	AR10L	OF7Z5-M-LC-07-400A-A1-E00-F4
iC7-60SL3AB5-380AE00F4	388	380	285	323	242	AM10L	AR10L	OF7Z5-M-LC-07-400A-A1-E00-F4
iC7-60SL3AB5-425AE00F4	434	425	318	361	270	AM12L	AR12L	OF7Z5-M-LC-07-1000-A1-E00-F4
iC7-60SL3AB5-475AE00F4	485	475	356	404	303	AM12L	AR12L	OF7Z5-M-LC-07-1000-A1-E00-F4
iC7-60SL3AB5-530AE00F4	542	530	397	450	337	AM12L	AR12L	OF7Z5-M-LC-07-1000-A1-E00-F4
iC7-60SL3AB5-595AE00F4	608	595	446	505	379	AM12L	AR12L	OF7Z5-M-LC-07-1000-A1-E00-F4
iC7-60SL3AB5-670AE00F4	684	670	502	569	427	AM12L	AR12L	OF7Z5-M-LC-07-1000-A1-E00-F4
iC7-60SL3AB5-760AE00F4	776	760	570	646	484	AM12L	AR12L	OF7Z5-M-LC-07-1000-A1-E00-F4
iC7-60SL3AB5-850AE00F4	868	850	637	722	541	2xAM12L	2xAR12L	OF7Z5-M-LC-07-1640-A1-E00-F4
iC7-60SL3AB5-945AE00F4	965	945	708	803	601	2xAM12L	2xAR12L	OF7Z5-M-LC-07-1640-A1-E00-F4
iC7-60SL3AB5-1040E00F4	1062	1040	780	883	662	2xAM12L	2xAR12L	OF7Z5-M-LC-07-1640-A1-E00-F4
iC7-60SL3AB5-1230E00F4	1256	1230	922	1044	783	2xAM12L	2xAR12L	OF7Z5-M-LC-07-1640-A1-E00-F4
iC7-60SL3AB5-1325E00F4	1353	1325	993	1125	843	2xAM12L	2xAR12L	OF7Z5-M-LC-07-1640-A1-E00-F4
iC7-60SL3AB5-1500E00F4	1532	1500	1125	1274	955	2xAM12L	2xAR12L	OF7Z5-M-LC-07-1640-A1-E00-F4
iC7-60SL3AB5-1700E00F4	1736	1700	1275	1443	1083	3xAM12L	3xAR12L	2xOF7Z5-M-LC-07-1640-A1-E00-F4
iC7-60SL3AB5-1800E00F4	1838	1800	1350	1528	1146	3xAM12L	3xAR12L	2xOF7Z5-M-LC-07-1640-A1-E00-F4
iC7-60SL3AB5-2000E00F4	2042	2000	1500	1698	1274	3xAM12L	3xAR12L	2xOF7Z5-M-LC-07-1640-A1-E00-F4
iC7-60SL3AB5-2250E00F4	2297	2250	1687	1910	1432	3xAM12L	3xAR12L	2xOF7Z5-M-LC-07-1640-A1-E00-F4
iC7-60SL3AB5-2500E00F4	2552	2500	1875	2122	1592	4xAM12L	4xAR12L	2xOF7Z5-M-LC-07-1640-A1-E00-F4
iC7-60SL3AB5-2650E00F4	2706	2650	1987	2250	1687	4xAM12L	4xAR12L	2xOF7Z5-M-LC-07-1640-A1-E00-F4
iC7-60SL3AB5-2940E00F4	3002	2940	2205	2496	1872	4xAM12L	4xAR12L	2xOF7Z5-M-LC-07-1640-A1-E00-F4

<sup>1)</sup> Main voltage 380-500 V AC (465-800 V DC) (Improved hardware transient withstand)

<sup>2)</sup> **Ratings are valid at 800V DC voltage**

I<sub>N</sub> Nominal (thermal) continuous current. Dimensioning can be done according to this current if the process does not require any overloadability

I<sub>L</sub> Low overloadability current (1/5min) Allows +10% load variation for 1 minute every 5 minutes.

I<sub>H</sub> High overloadability current (1/5min) Allows +50% load variation for 1 minute every 5 minutes.

<sup>3)</sup> All values with cosφ = 1.00, efficiency = 98.0% and rated voltage 742 VDC

<sup>4)</sup> Includes LC-filter with the option +AEZ1 and LCL-filter with the option +AEZ3 net side L-filter separate module



# Grid Converter module



## Grid Converter for advanced AC/DC power conversion

- Grid converter is a bi-directional AC/DC power converter for grid forming, advanced grid control and DC power supply applications
- Ideal for smart grid applications such as energy storage and DC power supply for hydrogen electrolysis.
- Stand-out solution for marine & offshore energy management applications such as energy storage, micro grid forming, shaft generators and shore power.

## Ratings

- 236-5750 A  $I_L$ , +10% overload 1 min/5 min
- 525-690 V AC / 640-1100 V DC (07)
- 380-500 V AC / 465-800 V DC (B5)
- 45-66 Hz Grid frequency (25-70 Hz with derating)
- THDi < 5% (< 3% with dedicated transformer)
- Adjustable power factor
- Ambient temperature 60 °C at  $I_N$

- Coolant temperature 45 °C at  $I_N$ , with the exception of 38 °C at  $I_N$  for current ratings 380 A, 760 A, 1500 A, 2250 A, 2940 A, 3600 A, 4320 A, 5040 A, 5750 A.

## Highlights

- Most compact AC/DC power conversion on the market thanks to integration of filters and fuses
- High short-circuit current injection capability reduces oversizing
- Meets the strictest harmonics requirements thanks to high DC and AC power quality
- Robust and reliable in varying ambient conditions
- Designed for fast enclosure integration and quick serviceability
- Lowest weight on the market thanks to new filter technology
- Same mechanical footprint and integration as INU, AFE and DC/DC modules

## State-of-the-art grid control

- Fast primary control ensures power system stability and streamlined power management
- Synchronize to external grid and compensate voltage drop thanks to dual-channel voltage measurement option
- Blackout prevention and black start
- Unrivalled paralleling options for high-power installations
- Flexible grid forming and grid following control modes to optimize system-level cost
  - DC-bus voltage
  - DC current/power
  - Active and reactive power
  - AC voltage & frequency
  - Island (grid forming)
  - Droop control
  - Droop with base load
  - Limit controllers
  - Smooth transition between grid-following and grid-forming control modes

# Grid converter (GC) ratings at 690 V AC

## iC7-60SLGC07, 525-690 V AC (640-1100 V DC), IP00/UL Open Type Grid Converter module

Product code	Current ratings <sup>1)</sup>					Power ratings <sup>2)</sup>		Frame size	Frame with option +AE
	3 x 525-690 V					690 V AC mains			
	I <sub>N</sub>	I <sub>L</sub>	I <sub>H</sub>	I <sub>S</sub>	I <sub>S2</sub>	P <sub>L</sub>	S <sub>L</sub>		
	[A]	[A]	[A]	[A]	[A]	[kW]	[kVA]		
iC7-60SLGC07-236AE00F4	241	236	177	354	330	277	283	AM10L	AR10L
iC7-60SLGC07-300AE00F4	307	300	225	450	420	352	359	AM10L	AR10L
iC7-60SLGC07-334AE00F4	341	334	250	501	468	392	400	AM10L	AR10L
iC7-60SLGC07-380AE00F4	388	380	285	570	532	446	455	AM10L	AR10L
iC7-60SLGC07-425AE00F4	434	425	318	638	595	498	508	AM12L	AR12L
iC7-60SLGC07-475AE00F4	485	475	356	712,5	665	557	568	AM12L	AR12L
iC7-60SLGC07-530AE00F4	542	530	397	795	742	621	634	AM12L	AR12L
iC7-60SLGC07-595AE00F4	608	595	446	892,5	833	697	712	AM12L	AR12L
iC7-60SLGC07-670AE00F4	684	670	502	1005	938	785	801	AM12L	AR12L
iC7-60SLGC07-760AE00F4	776	760	570	1140	1064	891	909	AM12L	AR12L
iC7-60SLGC07-850AE00F4	868	850	637	1275	1190	996	1016	2xAM12L	2xAR12L
iC7-60SLGC07-945AE00F4	965	945	708	1417,5	1323	1107	1130	2xAM12L	2xAR12L
iC7-60SLGC07-1040E00F4	1062	1040	780	1560	1456	1219	1243	2xAM12L	2xAR12L
iC7-60SLGC07-1230E00F4	1256	1230	922	1845	1722	1441	1470	2xAM12L	2xAR12L
iC7-60SLGC07-1325E00F4	1353	1325	993	1988	1855	1552	1584	2xAM12L	2xAR12L
iC7-60SLGC07-1500E00F4	1532	1500	1125	2250	2100	1757	1793	2xAM12L	2xAR12L
iC7-60SLGC07-1700E00F4	1736	1700	1275	2550	2380	1992	2032	3xAM12L	3xAR12L
iC7-60SLGC07-1800E00F4	1838	1800	1350	2700	2520	2109	2152	3xAM12L	3xAR12L
iC7-60SLGC07-2000E00F4	2042	2000	1500	3000	2800	2343	2391	3xAM12L	3xAR12L
iC7-60SLGC07-2250E00F4	2297	2250	1687	3375	3150	2636	2690	3xAM12L	3xAR12L
iC7-60SLGC07-2500E00F4	2552	2500	1875	3750	3500	2929	2988	4xAM12L	4xAR12L
iC7-60SLGC07-2650E00F4	2706	2650	1987	3975	3710	3104	3168	4xAM12L	4xAR12L
iC7-60SLGC07-2940E00F4	3002	2940	2205	4410	4116	3444	3514	4xAM12L	4xAR12L
iC7-60SLGC07-3120E00F4	3185	3120	2340	4680	4368	3655	3729	5xAM12L	5xAR12L
iC7-60SLGC07-3600E00F4	3675	3600	2700	5400	5040	4217	4303	5xAM12L	5xAR12L
iC7-60SLGC07-3900E00F4	3982	3900	2925	5850	5460	4568	4661	6xAM12L	6xAR12L
iC7-60SLGC07-4320E00F4	4410	4320	3240	6480	6048	5060	5163	6xAM12L	6xAR12L
iC7-60SLGC07-4750E00F4	4849	4750	3562	7125	6650	5564	5677	7xAM12L	7xAR12L
iC7-60SLGC07-5040E00F4	5145	5040	3780	7560	7056	5903	6024	7xAM12L	7xAR12L
iC7-60SLGC07-5400E00F4	5513	5400	4050	8100	7560	6325	6454	8xAM12L	8xAR12L
iC7-60SLGC07-5750E00F4	5870	5750	4312	8625	8050	6735	6872	8xAM12L	8xAR12L

<sup>1)</sup> Ratings are valid at 1025 V DC nominal voltage

I<sub>N</sub> Nominal (thermal) continuous current. Dimensioning can be done according to this current if the process does not require any overloadability

I<sub>L</sub> Low overload – 110% overload – 1 min every 5 min.

I<sub>H</sub> High overload – 150% overload – 1 min every 5 min.

I<sub>S</sub> Short-term current injection available for 1s

I<sub>S2</sub> Short-term current injection available for 3.0s

<sup>2)</sup> DC power is calculated with  $\cos\phi = 1$ , efficiency = 98% and at nominal 1025 V DC voltage



# Grid converter (GC) ratings at 500 V AC

## iC7-60SLGCB5, 380-500 V AC (465-800 V DC), IP00/UL Open Type Grid converter unit

Product code	Current ratings <sup>2)</sup>					Power ratings <sup>3)</sup>		Frame size	Frame with option +AE_ <sup>4)</sup>
	3 x 380-500 V					500 V AC mains			
	$I_N$	$I_L$	$I_H$	$I_S^{1)}$	$I_{S2}^{1)}$	$P_L$	$S_L$		
	[A]	[A]	[A]	[A]	[A]	[kW]	[kVA]		
iC7-60SLGCB5-261AE00F4	267	261	196	392	365	222	227	AM10L	AR10L
iC7-60SLGCB5-325AE00F4	332	325	244	488	455	276	282	AM10L	AR10L
iC7-60SLGCB5-380AE00F4	388	380	285	570	532	323	330	AM10L	AR10L
iC7-60SLGCB5-425AE00F4	434	425	318	638	595	361	369	AM12L	AR12L
iC7-60SLGCB5-475AE00F4	485	475	356	713	665	404	412	AM12L	AR12L
iC7-60SLGCB5-530AE00F4	542	530	397	795	742	450	459	AM12L	AR12L
iC7-60SLGCB5-595AE00F4	608	595	446	893	833	505	516	AM12L	AR12L
iC7-60SLGCB5-670AE00F4	684	670	502	1005	938	569	581	AM12L	AR12L
iC7-60SLGCB5-760AE00F4	776	760	570	1140	1064	646	659	AM12L	AR12L
iC7-60SLGCB5-850AE00F4	868	850	637	1275	1190	722	737	2xAM12L	2xAR12L
iC7-60SLGCB5-945AE00F4	965	945	708	1418	1323	803	819	2xAM12L	2xAR12L
iC7-60SLGCB5-1040E00F4	1062	1040	780	1560	1456	883	901	2xAM12L	2xAR12L
iC7-60SLGCB5-1230E00F4	1256	1230	922	1845	1722	1044	1066	2xAM12L	2xAR12L
iC7-60SLGCB5-1325E00F4	1353	1325	993	1988	1855	1125	1148	2xAM12L	2xAR12L
iC7-60SLGCB5-1500E00F4	1532	1500	1125	2250	2100	1274	1300	2xAM12L	2xAR12L
iC7-60SLGCB5-1700E00F4	1736	1700	1275	2550	2380	1443	1473	3xAM12L	3xAR12L
iC7-60SLGCB5-1800E00F4	1838	1800	1350	2700	2520	1528	1559	3xAM12L	3xAR12L
iC7-60SLGCB5-2000E00F4	2042	2000	1500	3000	2800	1698	1733	3xAM12L	3xAR12L
iC7-60SLGCB5-2250E00F4	2297	2250	1687	3375	3150	1910	1949	3xAM12L	3xAR12L
iC7-60SLGCB5-2500E00F4	2552	2500	1875	3750	3500	2122	2166	4xAM12L	4xAR12L
iC7-60SLGCB5-2650E00F4	2706	2650	1987	3975	3710	2250	2295	4xAM12L	4xAR12L
iC7-60SLGCB5-2940E00F4	3002	2940	2205	4410	4116	2496	2547	4xAM12L	4xAR12L

<sup>1)</sup> Main voltage 380...500 V AC (465...800 V DC) (Improved hardware transient withstand)

<sup>2)</sup> Ratings are valid at 800 V DC voltage

$I_N$  Nominal (thermal) continuous current. Dimensioning can be done according to this current if the process does not require any overloadability

$I_L$  Low overloadability current (1/5min) Allows +10% load variation for 1 minute every 5 minutes.

$I_H$  High overloadability current (1/5min) Allows +50% load variation for 1 minute every 5 minutes.

<sup>3)</sup> DC power is calculated with  $\cos \varphi = 1$ , efficiency = 98% and 742 V DC voltage

<sup>4)</sup> Includes LC-filter with the option +AEZ1 and LCL-filter with the option +AEZ3 (net side L-filter separate module)





# DC/DC Converter



## Tap in to the benefits of electrification with the DC/DC Converter

- DC/DC Converter is a bi-directional power converter enabling interconnection of two (DC) systems having different voltage levels
- Energy storage with wide voltage range can be connected to a stable DC bus
- Ideal for high-power battery or fuel cell applications
- Enables peak shaving and zero emission operation while providing additional redundancy.

## Ratings

- 300-3600 A  $I_L$ , +10% overload 1 min/5 min
- 640-1100 V DC bus (07)
- 465-800 V DC bus (B5)
- DC Source voltage range 3-100% of DC bus voltage. Full control performance 3-97% of DC bus voltage

- DC source current ripple (typical):
  - DR10L < 1% RMS (typical)
  - DR12L < 0.5% RMS (typical))
- Ambient temperature 60 °C at  $I_N$
- Coolant temperature 45 °C at  $I_N$ , with the exception of 38 °C at  $I_N$  for current ratings 1200 A, 2400 A, 3600 A

## Highlights

- Most compact DC/DC Converter on the market thanks to integration of filters and fuses
- Lowest weight on the market thanks to new filter technology
- Same mechanical footprint and integration as INU, AFE and GC.
- Meets strict DC power quality requirements
- Robust and reliable in varying ambient conditions
- Designed for enclosure integration and quick serviceability

## DC/DC Converter control

- Fast primary control ensures power system stability and streamlined power management
- Flexible control modes to optimize system-level cost and time to market
  - DC-bus voltage reference
  - Source voltage reference
  - Source power and current references
  - Current and voltage limit controllers
  - Smooth transition between control modes during run state
- Able to maintain stable DC bus voltage even when other power generation goes offline – added redundancy on top of the benefits of hybridization and electrification
- Black start capability

# DC/DC Converter (DC) ratings at 1025 V DC

## iC7-60SLDC07, 640-1100 V DC bus, IP00/UL Open Type DC/DC Converter

Model code	DC current			DC power	Frame	Frame with option +AE_
	$I_N$	$I_L$	$I_H$	1000..250 $V_{DC \text{ source}}$		
				$P_{L\text{-typ}}$		
[A]	[A]	[A]	[kW]			
iC7-60SLDC07-300AE00F4	307	300	225	300..75	DM10L	DR10L
iC7-60SLDC07-360AE00F4	368	360	270	360..90	DM10L	DR10L
iC7-60SLDC07-420AE00F4	429	420	315	420..105	DM10L	DR10L
iC7-60SLDC07-480AE00F4	490	480	360	480..120	DM10L	DR10L
iC7-60SLDC07-570AE00F4	582	570	428	570..142	DM10L	DR10L
iC7-60SLDC07-720AE00F4	735	720	540	720..180	DM12L	DR12L
iC7-60SLDC07-840AE00F4	858	840	630	840..210	DM12L	DR12L
iC7-60SLDC07-960AE00F4	980	960	720	960..240	DM12L	DR12L
iC7-60SLDC07-1080E00F4	1103	1080	810	1080..270	DM12L	DR12L
iC7-60SLDC07-1200E00F4	1225	1200	900	1200..300	DM12L	DR12L
iC7-60SLDC07-1440E00F4	1470	1440	1080	1440..360	2xDM12L	2xDR12L
iC7-60SLDC07-1680E00F4	1715	1680	1260	1680..420	2xDM12L	2xDR12L
iC7-60SLDC07-1920E00F4	1960	1920	1440	1920..480	2xDM12L	2xDR12L
iC7-60SLDC07-2160E00F4	2205	2160	1620	2160..540	2xDM12L	2xDR12L
iC7-60SLDC07-2400E00F4	2450	2400	1800	2400..600	2xDM12L	2xDR12L
iC7-60SLDC07-2880E00F4	2940	2880	2160	2880..720	3xDM12L	3xDR12L
iC7-60SLDC07-3240E00F4	3308	3240	2430	3240..810	3xDM12L	3xDR12L
iC7-60SLDC07-3600E00F4	3675	3600	2700	3600..900	3xDM12L	3xDR12L

**Ratings are valid at 1025 V nominal DC bus voltage**

$I_N$  Nominal (thermal) current. Dimensioning according  $I_N$  if the process does not require overloadability

$I_L$  Low overload – 110% overload – 1 min every 5 min

$I_H$  High overload – 150% overload for 1 min every 5 min

$P_{L\text{-typ}}$  is the DC source power with the stated source voltage and  $I_L$  current

DC bus current rating is equal to DC source current ratings (DC current)

Source voltage range 3..100% of DC bus voltage. Full control performance 3..97% of DC bus voltage

# DC/DC Converter (DC) ratings at 800 V DC

## iC7-60SLDCB5, 465-800 V DC bus, IP00/UL Open Type DC/DC Converter

Product code	DC current			DC power	Frame	Frame with option +AE_
	$I_N$	$I_L$	$I_H$	700..250 V <sub>DC source</sub>		
				$P_{L-typ}$		
[A]	[A]	[A]	[kW]			
iC7-60SLDCB5-300AE00F4	307	300	225	210..75	DM10L	DR10L
iC7-60SLDCB5-360AE00F4	368	360	270	252..90	DM10L	DR10L
iC7-60SLDCB5-420AE00F4	429	420	315	294..105	DM10L	DR10L
iC7-60SLDCB5-480AE00F4	490	480	360	336..120	DM10L	DR10L
iC7-60SLDCB5-570AE00F4	582	570	428	399..143	DM10L	DR10L
iC7-60SLDCB5-720AE00F4	735	720	540	504..180	DM12L	DR12L
iC7-60SLDCB5-840AE00F4	858	840	630	588..210	DM12L	DR12L
iC7-60SLDCB5-960AE00F4	980	960	720	672..240	DM12L	DR12L
iC7-60SLDCB5-1080E00F4	1103	1080	810	756..270	DM12L	DR12L
iC7-60SLDCB5-1200E00F4	1225	1200	900	840..300	DM12L	DR12L
iC7-60SLDCB5-1440E00F4	1470	1440	1080	1008..360	2xDM12L	2xDR12L
iC7-60SLDCB5-1680E00F4	1715	1680	1260	1176..420	2xDM12L	2xDR12L
iC7-60SLDCB5-1920E00F4	1960	1920	1440	1344..480	2xDM12L	2xDR12L
iC7-60SLDCB5-2160E00F4	2205	2160	1620	1512..540	2xDM12L	2xDR12L
iC7-60SLDCB5-2400E00F4	2450	2400	1800	1680..600	2xDM12L	2xDR12L
iC7-60SLDCB5-2880E00F4	2940	2880	2160	2016..720	3xDM12L	3xDR12L
iC7-60SLDCB5-3240E00F4	3308	3240	2430	2268..810	3xDM12L	3xDR12L
iC7-60SLDCB5-3600E00F4	3675	3600	2700	2520..900	3xDM12L	3xDR12L

### Ratings are valid at 800 V DC voltage

$I_N$  Nominal (thermal) current. Dimensioning according  $I_N$  if the process does not require overloadability

$I_L$  Low overload – 110% overload – 1 min every 5 min

$I_H$  High overload – 150% overload for 1 min every 5 min

$P_{L-typ}$  is the DC source power with the stated source voltage and  $I_L$  current

DC bus current rating is equal to DC source current ratings (DC current)

Source voltage range 3..100% of DC bus voltage. Full control performance 3..97% of DC bus voltage







# Dimensions and weight: INU, AFE, GC and DC/DC modules

Module type		Inverter		AFE and Grid Converter		Inverter with integration unit		AFE/Grid Converter with integration unit		DC/DC Converter		DC/DC Converter with integration unit	
Frame		IM10L	IM12L	AM10L	AM12L	IR10L	IR12L	AR10L	AR12L	DM10L	DM12L	DR10L	DR12L
[mm]	Width	140	235	140	235	140	235	140	235	140	235	140	235
	Height	710	710	710	710	1295	1295	1295	1295	710	710	1295	1295
	Depth	558	558	558	558	566	566	566	566	558	558	566	566
[kg]	Weight <sup>1)</sup>	41	80	41	80	106	178	138	230	41	80	130	230
[in]	Width	5.5	9.3	5.5	9.3	5.5	9.3	5.5	9.3	5.5	9.3	5.5	9.3
	Height	28	28	28	28	51	51	51	51	28	28	51	51
	Depth	22	22	22	22	22.3	22.3	22.3	22.3	22	22	22.3	22.3
[lb]	Weight <sup>1)</sup>	90	176	90	176	234	392	304	507	90	176	287	507

<sup>1)</sup>Weight includes integration unit with these filters installed:  
 IR10L, IR12L with dU/dt filter (+AEU1)  
 AR10L, AR12L with LC filter (+AEZ1)  
 DR10L, DR12L with DC/DC filter (+AED1)

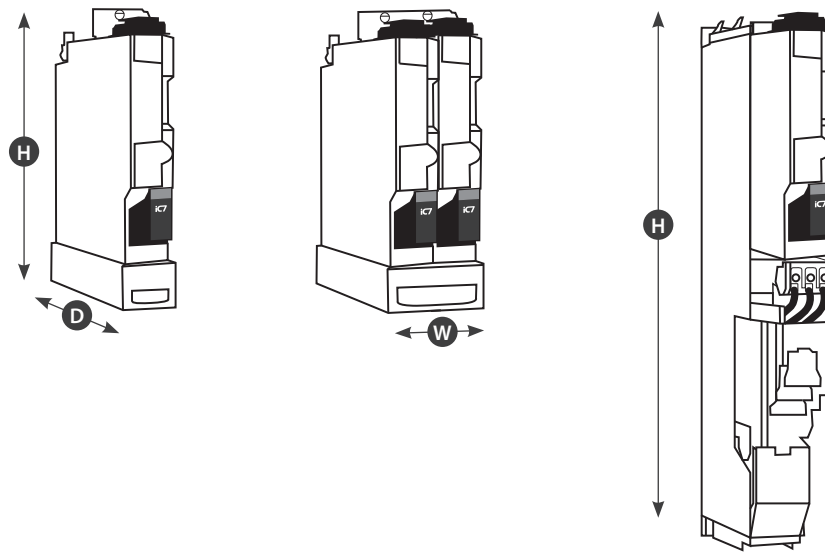

## Filters

Type	
Input filters	LC-filter and LCL-filter for Active front end and Grid converter modules
Output filters	dU/dt filter for INU module
	Sine-wave filter for INU module
	Common-mode filter for INU module IR10L
DC/DC filter	DC/DC filter for DC/DC converter modules
Filter features	IP00 (IP55 excluding power terminals)
	Dedicated liquid cooled filters with up to 90% of heat losses to liquid Very low losses to air reduce air conditioning load
	Unsurpassed power density, ultra compact, super lightweight filter concept – unmatched anywhere in the market
	Supports vertical and horizontal mounting

Filters are available integrated in the integration unit and separately as loose options, which enables low-height installations

# Enclosed Drives

## Need more freedom for streamlined integration?

iC7 series Enclosed Drives open up new application opportunities with flexible system integration in a wide range of industries.

Optimized for compact footprint, ease of use and fast serviceability, you can apply these drives to enhance motor control. A range of variants and options equip you to make precisely the right choices ensuring high performance and local compliance, including harmonic compliance.

Most importantly, you can count on the Enclosed Drives for exceptional reliability, being founded in fully traceable end-to-end quality processes.

### Compact

Sophisticated heat management is a key factor endowing the Enclosed Drives with a compact footprint. These drives are equipped with heatpipe-based thermal management, optional back-channel cooling, and segregated main and auxiliary cooling channels. All of these technologies reduce the drive dimensions, enable reduction of air-conditioning load, and even enable you to cut down on space in the electrical room.

### Versatile

iC7 Enclosed Drives are available in standard cabinet sizes, configured in the right variant to suit your application:

- 6-pulse, low-harmonic, and regenerative variants
- Wide range of options

## HIGHLIGHTS

- **Streamlined system integration**
- **Fast and safe service access**
- **6-pulse, low-harmonic, and regenerative variants**
- **Intelligent heat management**
- **Modular control**
- **Small footprint thanks to cutting-edge heat management**
- **Wide range of cabinet options**

## Safe

and fast service access





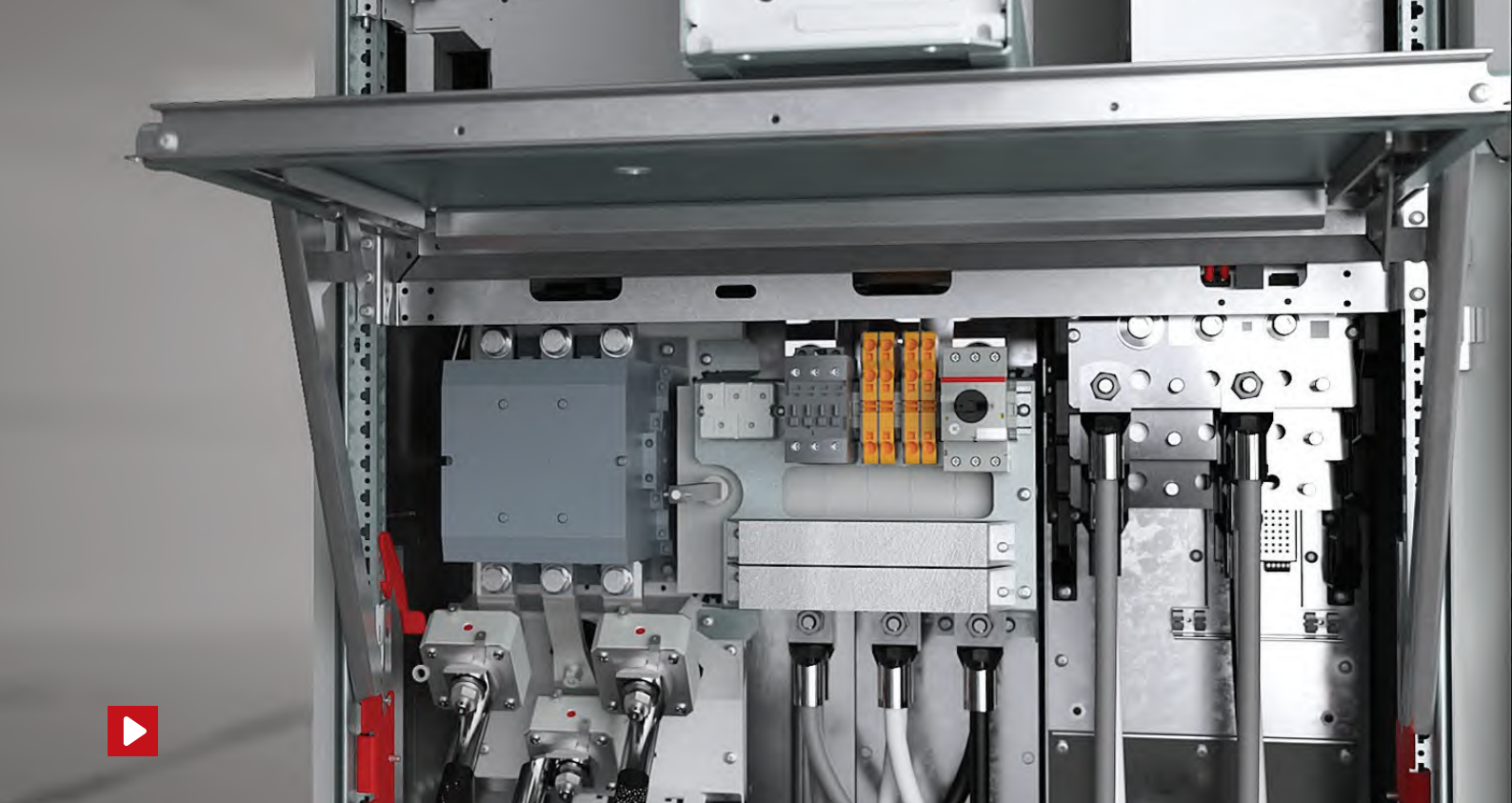

## Scalability and speedy service

### High power density cooling

You get high power density thanks to superior heat management using heatpipe technology and high-performance heat sinks. Closed air ducts enable flexible mounting, and back-channel cooling supports removal of heat to the surroundings without extra cooling equipment. Remove fans easily for cleaning and service.

### Environmental exposure

The iC7 drive delivers exceptional performance under demanding operating conditions, according to the environmental standard IEC60721.

The ability to operate at ambient temperatures ranging from -15 °C to 40 °C (55 °C with derating) ensures

the drive meets a broad range of application requirements. With an altitude capability of up to 4000 m (13124 ft) above sea level, you can install this drive in virtually any location.

This robust drive matches the required vibration resistance for operation in cabinets, in control rooms and on machines.

### ▶ Accessibility video

### Fast and safe serviceability

Access cables easily with no need to remove the power module.

Service access is extremely convenient and fast with integrated service table, and optional hoist bracket on top of the cabinet. Remove the power module easily, with no need to remove motor cabling. The control compartment door-in-door concept aids safe and fast work and you can swing out the control compartment frame easily to access the power modules.

### ▶ Efficient maintenance video

# Modular architecture: Setting the **standard** for modular **control**

Flexible modular control architecture means you can tailor the control functionality exactly to your needs. You can purchase exactly the control options you need. You can also use drive options as an alternative to external components such as PLC components, I/O and external safety components.

This modularity gives you not only more flexibility, but more secure integration of drives in the control system and IT architecture. You achieve faster set-up, and smarter monitoring, data gathering and analytics thanks to support for multiple communication network types.

The purchase cost is lower since you only buy the necessary control options, saving excess unused functionality. The drive can reduce your costs further by substituting for a low-end PLC controller/system, thanks to its IEC 61131-based control architecture.

## Features

- Expandable bus includes I/O, fieldbus, and expanded safety options
- Choose between a variety of control options
- Options are slot-independent with 6 option board slots available
- Integrated microSD card slot
- Integrated STO SIL3 safety
- Programmable
- Use the same options interchangeably in all drives in the iC7 series

## Technical information

- Integrated Ethernet communication interfaces
- Dual-channel STO SIL3 integrated as standard
- Optional fieldbus protocols
- Standard I/O:  
6 x DI, 2 x DO, 2 x AI +/-10V/0-20 mA, 1 x AO (0-10/4-20 mA), 2 x NO/NC RO, 1 x NO RO, 1 x Thermistor input
- Optical fiber as communication link with power module(s)

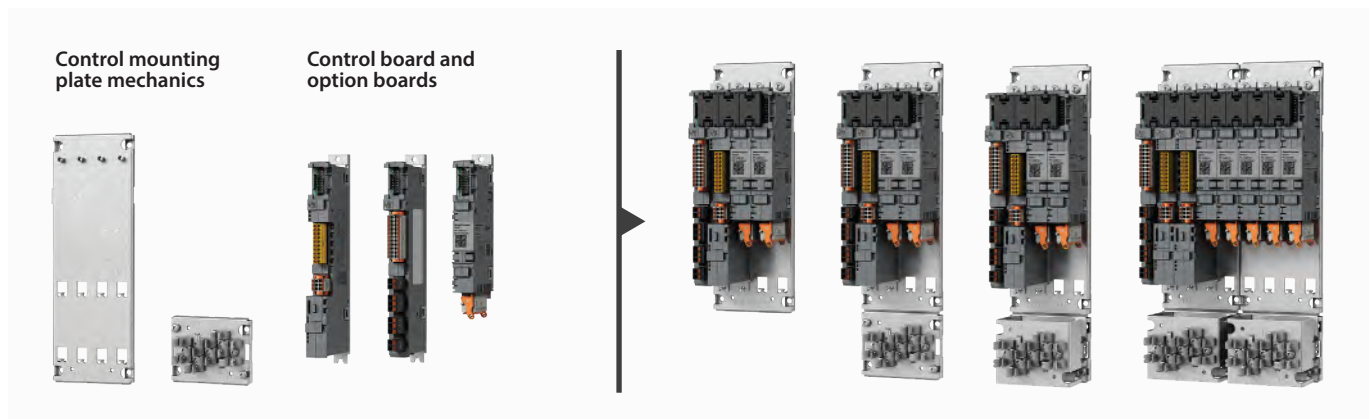





## Features and benefits

Feature	Benefit
<b>Robust by design, high uptime and quality</b>	– Reliable in heavy-duty service
<b>Segregated main cooling channel, (IP21 or IP54) and dedicated PCB area</b>	– Extremely reliable in heavy-duty service
<b>Wide range of pre-designed options</b>	– Flexible to meet any application need
<b>Heat management using heat pipe technology and segregated main cooling channel</b>	– High power density, reduced footprint
<b>Integrated options such as functional extensions, output filters, fuses and disconnects mean no extra external devices are required</b>	– Save cost and time in installation
<b>Installer-friendly design includes pluggable control terminals, easy-access power terminals, and easily replaceable fans</b>	– Save cost and time in installation and service
<b>Modular and scalable solutions for high powers Simplified spare unit handling</b>	– Fast integration and serviceability
<b>Pull-out of power unit without removing motor or mains cables, included with integration unit</b>	– Fast and easy serviceability
<b>Safe door-in-door access to the control compartment</b>	– Safe and fast serviceability

Ensuring you shine in the marketplace is our goal. Learn how Danfoss supports your success [here](#) 

# Key specifications for 6-pulse, low-harmonic or regenerative enclosed drives

Environmental	6-pulse	Low-harmonic & regenerative
Voltage rating	3 x 380-500 V AC, -20%/+10%	
Current range	206-588 A	385-1710 A
Overload capacity	110/150% for 1 minute every 5 minutes <sup>1)</sup>	
Protection rating	IP21/UL Type 1, IP54	

<sup>1)</sup> 1 minute every 10 minutes, for frames FE9 and FE10  
1 minute every 5 minutes, for all other frames

## Technical data <sup>1)</sup>

Input	
Voltage rating	380-500 V AC, +10%/-15%
Supply frequency	50/60 Hz
Switching on input <sup>2)</sup>	6-pulse: 1-2 times per minute Low-harmonic and regenerative: Switch on twice at 60 s interval, followed by 10 minutes cooling-down period
Grid type	TN, TT, IT, Delta

Output	
Output frequency	0-599 Hz
Switching on output	Unlimited
Overload capacity	110% and 150%

Environmental conditions	
Rated temperature	-15 to 40 °C (5 to 104 °F)
Maximum temperature with derating	55 °C (131 °F)
Rated altitude	1000 m (3300 feet) or up to 4,000 m (13,124 ft) with derating
Relative humidity	5-95% non condensing

Functional Safety I/O	
STO	Dual-channel, with galvanic isolation
STO feedback	Single channel, with galvanic isolation

External supply	
Rating	24 V/2 A

Basic I/O	
Digital inputs	6, single-ended
Relay outputs	3 • 2 x NO, NC • 1 x NO • 250 V AC 3 A max. (50/60 Hz) • 24 V DC 2
Analog inputs	2 • -20/0 to +20 mA or • -10/0 to +10 V
Analog output	1 • 0-20 mA or • 0-10 V resistive load
Thermistor input	1, isolated

Compliance	
Compliance	IEC 61800-5-1 UL 61800-5-1

<sup>1)</sup> Preliminary values pending validation.

<sup>2)</sup> Refer to Design Guide for more information.

<sup>3)</sup> 2 of the inputs can be reconfigured to outputs

## Control options

Functional extensions	Description
General Purpose I/O OC7C0	General purpose I/O extension board (3xDI, 2xDO, 2xAI, 1xAO)
Relay Option OC7R0	Relay I/O extension board, with 3 relays
Encoder/Resolver Option OC7M0	Encoder/Resolver extension board (TTL, HTL, SinCos, SSI, HIPERFACE, EnDat, BiSS, resolver)
Temperature Measurement OC7T0	Temperature measurement extension board with 5 channels
I/O and Relay Option OC7C1	I/O extension

## Ratings 6-pulse enclosed drives <sup>1)</sup>

Designation	Rated output current						Typical shaft output power		Frame
	3 x 380-440 V			3 x 441-500 V			400 V	460 V	
	$I_N$	$I_L$	$I_H$	$I_N$	$I_L$	$I_H$	$P_L$	$P_L$	
	[A]	[A]	[A]	[A]	[A]	[A]	[kW]	[HP]	
iC7-60EA3N05-206A	211	206	170	201	196	166	110	150	FE9
iC7-60EA3N05-245A	251	245	206	245	240	196	132	200	FE9
iC7-60EA3N05-300A	309	302	245	309	302	240	160	250	FE9
iC7-60EA3N05-385A	394	385	302	372	364	302	200	300	FE9
iC7-60EA3N05-480A	490	480	385	466	456	364	250	350	FE10
iC7-60EA3N05-588A	601	588	480	531	520	456	315	450	FE10

<sup>1)</sup> Preliminary values pending validation.

$I_L$ : Low overload – 110% overload – 1 min every 5 min

$I_H$ : High overload – 150% overload – 1 min every 10 min for frames FE9 and FE10; 1 min every 5 min for all other frames

## Ratings low-harmonic & regenerative enclosed drives <sup>1)</sup>

Designation	Rated output current						Typical shaft output power		Frame
	3 x 380-440 V			3 x 441/481-500 V			400 V	460 V	
	$I_N$	$I_L$	$I_H$	$I_N$	$I_L$	$I_H$	$P_L$	$P_L$	
	[A]	[A]	[A]	[A]	[A]	[A]	[kW]	[HP]	
iC7-60EA3A05-385A	394	385	300	372	364	300	200	300	AE10+IE10
iC7-60EA3A05-480A	490	480	385	466	456	364	250	350	AE10+IE10
iC7-60EA3A05-588A	601	588	480	531	520	456	315	450	AE10+IE10
iC7-60EA3A05-658A	672	658	547	603	590	490	355	500	AE11+IE11
iC7-60EA3A05-730A	746	730	606	672	658	547	400	550	AE11+IE11
iC7-60EA3A05-820A	838	820	681	746	730	606	450	600	AE11+IE11
iC7-60EA3A05-880A	899	880	731	838	820	681	500	750	AE11+IE11
iC7-60EA3A05-1000	1021	1000	830	940	920	764	560	750	2xAE10+2xIE10
iC7-60EA3A05-1100	1123	1100	913	1052	1030	855	630	850	2xAE10+2xIE10
iC7-60EA3A05-1260	1287	1260	1050	1174	1150	960	710	950	2xAE11+2xIE11
iC7-60EA3A05-1450	1481	1450	1210	1328	1300	1080	800	1100	2xAE11+2xIE11
iC7-60EA3A05-1710	1746	1710	1420	1603	1570	1310	900	1300	2xAE11+2xIE11

<sup>1)</sup> Preliminary values pending validation.

$I_L$ : Low overload – 110% overload – 1 min every 10 min

$I_H$ : High overload – 150% overload – 1 min every 5 min

## Cabinet options

<b>Mains input device</b>	+GAXX	None
	+GACO	Mains contactor and switch
	+GAMS	Mains switch
	+GACB	Air circuit breaker fixed
<b>Grounding device provision</b>	+GCXX	None
	+GCEP	Provision for grounding device
	+GCES	Grounding switch
<b>Motor heater control</b>	+IAXX	None
	+IAMH	Yes
<b>Cabinet heater</b>	+IBXX	None
	+IBCH	Yes
<b>Motor fan control</b>	+ICXX	None
	+ICFC	Motor fan control
	+ICF1	Motor fan ctrl/supply 2.5-4 A
	+ICF2	Motor fan ctrl/supply 4-6.3 A
	+ICF3	Motor fan ctrl/supply 6.3-10 A
	+ICF4	Motor fan ctrl/supply 10-16 A
<b>Motor brake control</b>	+IDXX	None
	+IDBC	Motor brake control
<b>Control power supply</b>	+IFXX	None
	+IFCS	24 VDC
<b>Service socket</b>	+IGXX	None
	+IGS0	230 VAC socket CEE 7/3
	+IGS1	115 VAC socket, US
	+IGS2	230 VAC socket, UK
<b>Auxillary voltage supply</b>	+IHXX	None
	+IHAT	AC voltage transformer
	+IHAS	AC supply terminals
<b>Door signal lights</b>	+IIXX	None
	+IICD	Run, ready, fault
<b>Emergency stop button</b>	+ILXX	None
	+ILSS	STO/SS1 push button on door
<b>Mains cabling direction</b>	+KCIB	Bottom-entry
	+KCIT	Top-entry
	+KDOB	Bottom-entry
	+KDOT	Top-entry
<b>Cable entry plate</b>	+KFXX	With standard glands
	+KFCP	Blank plate without holes (UL)
<b>Output filter</b>	+MAXX	None
	+MAC2	Common-mode Filter
	+MAU2	dU/dt + CM Filter
	+MAU1	dU/dt Filter
<b>Air-cooling options</b>	+OAXX	Standard
	+OAOF	Cooling air outlet flange
	+OABC	Back-channel cooling
<b>Maintenance options</b>	+QAXX	None
	+QALS	Lifting support for power unit



# DYNAMIC PARAMETERS

PROXY POINT 0)

WATCHDOG ARM 24105

50210

(PROXY POINT 0)

FOG SWITCH/FOG ARM 1101

24105  
1018 50210

# SYSTEM HEALTH



(P1)

(P2)

A-12 E5 01-1

E-04 J

TOP\_04 A-2

TOP\_04 A-2



(PROXY POINT 2)

FOG SWITCH/FOG ARM

PROFLETAB (03)

(PROXY POINT 2)

FOG SWITCH/FOG ARM

PROFLETAB (03)

(P3)

(P4)

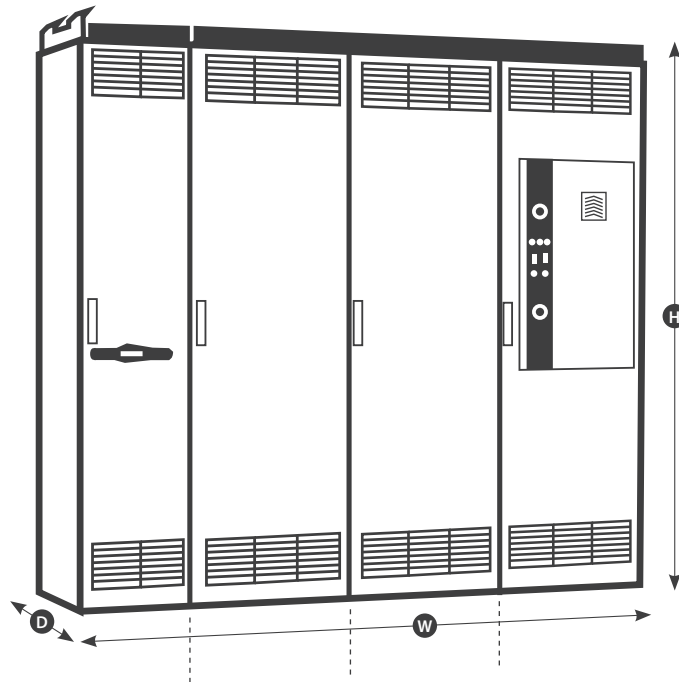

## Dimensions

Frame		6-pulse enclosed drives		Low-harmonic & regenerative enclosed drives			
		FE09	FE10	AE10 + IE10	AE11 + IE11	2 x AE10 + 2 x IE10	2 x AE11 + 2 x IE11
[mm]	Width	400	600	800	1200	2200	2400
	Height	2300 <sup>1)</sup>	2300 <sup>1)</sup>	2300 <sup>1)2)</sup>	2300 <sup>1)2)</sup>	2300 <sup>1)2)</sup>	2300 <sup>1)2)</sup>
	Depth	600	600	600	600	600	600
[in]	Width	15.7	23.6	31.5	47.2	86.6	94.5
	Height	90.6 <sup>1)</sup>	90.6 <sup>1)</sup>	90.6 <sup>1)2)</sup>	90.6 <sup>1)2)</sup>	90.6 <sup>1)2)</sup>	90.6 <sup>1)2)</sup>
	Depth	23.6	23.6	23.6	23.6	23.6	23.6

<sup>1)</sup> With 200 mm/7.8 in plinth and lifting rails, without lifting rails -101 mm/4.0 in

<sup>2)</sup> If IP21 cabinet total height is 2400 mm/94.5 in







The Danfoss logo is written in a white, cursive script font on a red rectangular background.

ENGINEERING  
TOMORROW



Imagine versatile and highly secure power conversion and motor control. Intensely powerful and compact converters and drives built to optimize a vast range of systems while giving you the flexibility to distribute intelligence the way you want. Paving the way for a new dimension, where open, connected and intelligent systems are the new reality.



 **Open up a new dimension with iC7 series**  
iC7-Automation | iC7-Marine | iC7-Hybrid

**Contact us** 

AD473637949861en-000201 | © Copyright Danfoss Drives | 2024.03

Any information, including, but not limited to information on selection of product, its application or use, product design, weight, dimensions, capacity or any other technical data in product manuals, catalogues descriptions, advertisements, etc. and whether made available in writing, orally, electronically, online or via download, shall be considered informative, and is only binding if and to the extent, explicit reference is made in a quotation or order confirmation. Danfoss cannot accept any responsibility for possible errors in catalogues, brochures, videos and other material. Danfoss reserves the right to alter its products without notice. This also applies to products ordered but not delivered provided that such alterations can be made without changes to form, fit or function of the product. All trademarks in this material are property of Danfoss A/S or Danfoss group companies. Danfoss and the Danfoss logo are trademarks of Danfoss A/S. All rights reserved.