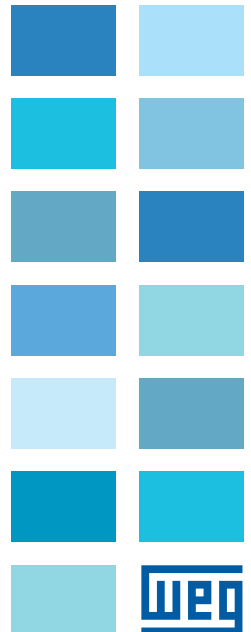




Soft-Starter

SSW-07 / SSW-08

Programming Manual



Programming Manual

Series: SSW-07 / SSW-08

Language: English

Document Number: 0899.5665 / 08

Software Version: V1.5X

Publication Date: 08/2015

SUMMARY

QUICK PARAMETER REFERENCE FAULT AND STATUS MESSAGES	4
I. PARAMETERS TABLE	4
II. FAULTMESSAGES	9
III. OTHER MESSAGES	9
1. GENERAL INFORMATION	10
2. ABOUT THIS MANUAL	10
3. ABOUT THE SSW-07/SSW-08	10
4. ABOUT THE SSW-07/SSW-08 PARAMETER PROGRAMMING	10
5. KEYPAD(HMI) USE	10
5.1. LEDs Display Functions	11
5.2. Function of the "Local" and "Remote" LEDs	11
5.3. Function of the Direction of Rotation LEDs (Clockwise and Counterclockwise)	11
5.4. Basic Functions of the Keys	12
5.5. Signaling/Indications on the Keypad Display	12
5.6. Parameter Viewing/Changing	12
6. DETAILED DESCRIPTION OF THE PARAMATERS	14
6.1. ACCESS AND READ ONLY PARAMETERS – P000 to P099	15
6.2. REGULATION PARAMETERS - P100 to P199	17
6.3. CONFIGURATION PARAMETERS - P200 to P299	20
6.4. COMMUNICATION PARAMETERS – P300 to P399	27
6.5. MOTOR PARAMETERS – P400 to P499	29
6.6. PARAMETERS OF THE SPECIAL FUNCTIONS – P500 to P599	30
6.7. PROTECTION PARAMETERS – P600 to P699	31
7. ERRORS AND POSSIBLE CAUSES	37

QUICK PARAMETER REFERENCE FAULT AND STATUS MESSAGES

Software: V1.5x

Application:

Model:

Serial Number:

Responsible:

Date: / / .

I. PARAMETERS TABLE

Parameter	Function	Adjustable Range	Factory Settings	Unit	User's Settings	Page
P000	Access to parameters	0 to 9999	0 (5)	-		15
READ ONLY PARAMETERS		P001 to P099				
P001	Motor current %In of SSW-07/SSW-08	0.0 to 999.9	-	%		15
P002	Motor current %In of Motor	0.0 to 999.9	-	%		15
P003	Motor current	0.0 to 6553	-	A		15
P005	Power supply frequency	0.0 to 99.9	-	Hz		15
P006	Soft-Starter Status	0 = rdy - ready 2 = Exx - Error 3 = ruP - Ramp Up 5 = PASS - By-pass 7 = rdo - Ramp Down 8 = br - Braking 9 = rEv - FWD/REV 10 = JoG - Jog 11 = dly - Delay P630 12 = G.di - General Disable	-	-		15
P007	Voltage imposed by the Soft-Starter over the load (%Un)	0 to 100	-	%		15
P011	Apparent output power	0.0 to 999.9	-	kVA		15
P012	DI1 to DI3 status	0 = Inactive 1 = Active	-	-		15
P013	Relay RL1 and RL2 output status	0 = Inactive 1 = Active	-	-		16
P014	Last fault occurred	E00 to E77	-	-		16
P015	Second fault occurred	E00 to E77	-	-		16
P016	Third fault occurred	E00 to E77	-	-		16
P017	Fourth fault occurred	E00 to E77	-	-		16
P020	Actual Fault	0...99	-	-		16
P023	Software version	x.xx	-	-		16
P030	Phase R current	0.0 to 6553	-	A		17
P031	Phase S current	0.0 to 6553	-	A		17
P032	Phase T current	0.0 to 6553	-	A		17
P050	Motor thermal protection status	0 to 250	-	%		17
P081	Heatsink temperature	10.0 to 110.0	-	°C		17
P090	CAN Controller Status	0 = Inactive 1 = Autobaud 2 = Active CAN Interface 3 = Warning 4 = Error passive 5 = Bus off 6 = No Bus Power	-	-		17
P091	DeviceNet Network Status	0 = Offline 1 = Online, Not Connected 2 = Online, Connected 3 = Expire Connection 4 = Connection Failure 5 = Auto-Baud	-	-		17
P092	DeviceNet Master Status	0 = Run 1 = Idle	-	-		17
P093	Received CAN Telegram Counter	0 to 9999	-	-		17
P094	Transmitted CAN Telegram Counter	0 to 9999	-	-		17
P095	Buss Off Error Counter	0 to 9999	-	-		17
P096	Lost Can Message Counter	0 to 9999	-	-		17
REGULATION PARAMETERS		P100 to P199				
Ramps						
P101(3)	Initial voltage (%Un)	30 to 90	50	%		17

Parameter	Function	Adjustable Range	Factory Settings	Unit	User's Settings	Page
P102 ⁽³⁾	Acceleration ramp time	1 to 999	20	s		18
P103	Deceleration Voltage Step (% Un)	100 = Inactive 99...60	100	%		18
P104 ⁽³⁾	Deceleration ramp time	0=Inactive 1 to 240	0=Inactive	s		19
P105	End Deceleration Voltage (% Un)	30...55	30	%		19
Current Limitation						
P110 ⁽³⁾	Current limitation (%In of the Soft-Starter)	30 to 500	300	%		19
P111	Initial Current for Current Ramp (%In of the Soft-Starter)	30...500	150	%		19
P112	Time for the Current Ramp (% of P102)	1...99	20	%		20
CONFIGURATION PARAMETERS P200 to P299						
Generic Parameters						
P200	The password is	0 = Inactive 1 = Active	1 = Active	-		20
P202	Type of Control	0=Voltage Ramp 1=Current Limit 2=Pump Control 3=No Function 4=Current Ramp 5=Direct Online (DOL)	0	-		21
P203	Fan Control	0 = Fan is always OFF 1 = Fan is always ON 2 = Fan controlled by software	2 = Fan controlled by software	-		22
P204 ⁽¹⁾	Load parameters with factory default values	0 = No function 1 = No function 2 = No function 3 = No function 4 = No function 5 = Loads factory default values	0 = No function	-		22
P205	Reading parameter selection	0 to 999	1 = P001	-		22
P206	Auto-reset time	3 to 1200	900	s		22
P207 ⁽³⁾	Auto-reset	0 = Inactive 1 = Active	0 = Inactive			22
P215 ⁽¹⁾	Copy function	0 = Inactive 1 = SSW → Keypad 2 = Keypad → SSW	0 = Inactive	-		23
P219	Parameterization via Keypad / (Trim pots and DIP Switch)	0=Trim pots and DIP Switch 1=Keypad 2=P202=2 / Trim pots and DIP	0	-		24
Local/Remote Definition						
P220 ⁽¹⁾	Local/remote supply selection	0 = Always local 1 = Always remote 2 = Keypad (local default) 3 = Keypad (remote default) 4 = DI1 to DI3 5 = Serial (local default) 6 = Serial (remote default) 7 = Fieldbus (Default Local) 8 = Fieldbus (Default Remote)	3 = Keypad (default remote)	-		24
P229 ⁽¹⁾	Command selection – local situation	0 = Keypad 1 = Digital Input DIx 2 = Serial 3 = Fieldbus	0 = Keypad	-		24
P230 ⁽¹⁾	Command selection – remote situation	0 = Keypad 1 = Digital Input DIx 2 = Serial 3 = Fieldbus	1 = Digital Input DIx	-		24

Parameter	Function	Adjustable Range	Factory Settings	Unit	User's Settings	Page
Digital Inputs						
P263	Digital Input DI1 Function	0=No Function 1=Start/Stop (two wires) or Start (three wires) 2=Local/Remote 3=No External Fault 4=FWD/REV 5=Brake Off 6=Reset 7=No Function 8=Jog	1	-		25
P264	Digital Input DI2 Function	0=No Function 1=Stop (Three-wires) 2=Local/Remote 3=No External Fault 4=FWD/REV 5=Brake Off 6=Reset 7=Emergency Start 8=Jog	6	-		25
P265 ⁽¹⁾	Input DI3 function	0 = No function 1 = General enable 2 = Local/Remote 3 = No external fault 4 = FWD/REV 5 = Brake off 6 = Reset 7 = Emergency Start 8 = Jog	6 = Reset	-		25
Relay Outputs						
P277	RL1 Relay Function	0=No Function 1=Running 2=Full Voltage 3=No Function 4=FWD/REV - K1 5=DC-Brake 6=No Fault 7=Fault 8=No Function 9=Serial 13=Shunt Trip	1	-		26
P278	RL2 Relay Function	0=No Function 1=Running 2=Full Voltage 3=No Function 4=FWD/REV - K2 5=DC-Brake 6=No Fault 7=Fault 8=No Function 9=Serial 13=Shunt Trip	2	-		26
Soft-Starter Data						
P295 ⁽¹⁾⁽²⁾	Nominal current	0 = 1.7A 1 = 17A 2 = 24A 3 = 30A 4 = 45A 5 = 61A 6 = 85A 7 = 130A 8 = 171A 9 = 200A 10 = 255A 11 = 312A 12 = 365A 13 = 412A	According to the Soft-Starter SSW-07/SSW-08 nominal current	A		27
COMMUNICATION PARAMETERS P300 to P399						
Serial Communication						
P308 ⁽¹⁾⁽²⁾	Soft-Starter address	1 to 247	1	-		27

Parameter	Function	Adjustable Range	Factory Settings	Unit	User's Settings	Page
P312 ⁽¹⁾⁽²⁾	Type of protocol and serial communication transmission rate	1 = Modbus 9600bps no parity 2 = Modbus 9600bps odd parity 3 = Modbus 9600bps even parity 4 = Modbus 19200bps no parity 5 = Modbus 19200bps odd parity 6 = Modbus 19200bps even parity 7 = Modbus 38400bps no parity 8 = Modbus 38400bps odd parity 9 = Modbus 38400bps even parity	1 = Modbus 9600bps no parity	-		27
P313	Serial communication error action (E28)	0 = Inactive 1 = Disable 2 = General disable 3 = Change to local	1 = Disable	-		28
P314 ⁽³⁾	Serial communication verification time	0 = Inactive 1 to 999	0 = Inactive	s		28
Fieldbus Communication						
P331	CAN Address	0 to 63	63	-		28
P332	CAN Baud Rate	0 = 125 Kbps 1 = 250 Kbps 2 = 500 Kbps 3 = Autobaud	3 = Autobaud	-		28
P333	Bus Off Reset	0 = Manual 1 = Automatic	0 = Manual	-		28
P335	DeviceNet I/O Instances	0 = ODVA 1 = WEG Specific 1W 2 = WEG Specific 2W 3 = WEG Specific 3W 4 = WEG Specific 4W 5 = WEG Specific 5W 6 = WEG Specific 6W 7 = WEG Specific 7W	0 = ODVA	-		28
P336	DeviceNet Reading Word #2	0 to 999	0	-		28
P337	DeviceNet Reading Word #3	0 to 999	0	-		28
P338	DeviceNet Reading Word #4	0 to 999	0	-		28
P339	DeviceNet Reading Word #5	0 to 999	0	-		28
P340	DeviceNet Reading Word #6	0 to 999	0	-		28
P341	DeviceNet Reading Word #7	0 to 999	0	-		28
P342	DeviceNet Writing Word #2	0 to 999	0	-		28
P343	DeviceNet Writing Word #3	0 to 999	0	-		28
P344	DeviceNet Writing Word #4	0 to 999	0	-		28
P345	DeviceNet Writing Word #5	0 to 999	0	-		28
P346	DeviceNet Writing Word #6	0 to 999	0	-		28
P347	DeviceNet Writing Word #7	0 to 999	0	-		28
P348	Fieldbus communication error action	0 = Inactive 1 = Disable 2 = General Disable 3 = Change to local	1 = Disable	-		28
MOTOR PARAMETERS P400 to P499						
Nominal Parameters						
P400 ⁽¹⁾	Motor nominal voltage	1 to 999	380	V		29
P401 ⁽¹⁾⁽³⁾	Motor current setting	30.0 to 100.0	100.0	%		29
P406 ⁽¹⁾	Service factor	1.00 to 1.50	1.00	-		29
SPECIAL FUNCTIONS PARAMETERS P500 to P599						
Braking						
P501	DC Braking Time	0...299 0=Inactive	0	s		29
P502	DC Braking Voltage Level	30...70	30	%		29
P510	Jog	0=Inactive 1=Active	0	-		30
P511	Jog Level	30...70	30	%		30

Parameter	Function	Adjustable Range	Factory Settings	Unit	User's Settings	Page
Kick Start						
P520 ⁽¹⁾⁽³⁾	Voltage pulse at start (Kick Start)	0 = Inactive 1 = Active	0 = Inactive	-		30
P521 ⁽³⁾	Pulse time at start	0.2 to 2.0	0.2	s		30
P522	Voltage pulse level at start (%Un)	70 to 90	80	%		30
PROTECTION PARAMETERS P600 to P699						
Current Protections						
P610 ⁽¹⁾	Phase Loss or Immediate Undercurrent (% In of the Motor)	1 to 80	80	%		31
P611 ⁽¹⁾⁽³⁾	Immediate undercurrent time or phase loss	0 = Inactive 1 to 99	1	s		31
P612 ⁽¹⁾	Immediate overcurrent (%In of motor)	1 to 200	100	%		31
P613 ⁽¹⁾⁽³⁾	Immediate overcurrent time	0 = Inactive 1 to 99	1	s		31
P614 ⁽¹⁾	Current imbalance between phases (%In of motor)	0 to 30	15	%		32
P615 ⁽¹⁾	Current imbalance time between phases	0 = Inactive 1 to 99	0 = Inactive	s		32
P616 ⁽¹⁾	Undercurrent before By-Pass closing	0 = Inactive 1 = Active	0 = Inactive	-		32
P617 ⁽¹⁾⁽³⁾	Blocked Rotor	0 = Inactive 1 = Active	1 = Active	-		32
Phase Sequence						
P620 ⁽¹⁾⁽³⁾	RST phase sequence	0 = Inactive 1 = Active	1 = Active	-		32
P621	E77 Enabling	0 = Inactive 1 = Active	1 = Active	-		32
SSW Short Circuit Detection						
P622 ⁽¹⁾	SSW short circuit	0 = Inactive 1 = Active	0 = Inactive			32
Interval Between Starts						
P630	Time interval after stopping	2 to 999	2	s		33
Motor Thermal Protection						
P640 ⁽¹⁾⁽³⁾	Motor protection thermal class	0 = Inactive 1 = 5 2 = 10 3 = 15 4 = 20 5 = 25 6 = 30	6 = 30	-		34
P641 ⁽¹⁾	Thermal memory auto-reset	0 = Inactive 1 to 600	0 = Inactive	s		36

(1) Changeable parameters only when the motor is disabled.

(2) Unchanged parameters at factory default settings (P204=5).

(3) Changeable parameters only in keypad mode (P219=1). If P219=0 the parameters are read only.

II. FAULT MESSAGES

Indication	Meaning	Page
E03	Phase loss or undercurrent	37
E04	Overtemperature on power	37
E05	Overload on motor	37
E06	External fault (DI)	38
E10	Function copy fault	38
E19	SSW short circuit	38
E24	Programming fault	38
E28	Timeout fault at telegram reception	38
E31	Keypad connection failure	38
E62	Current limitation start timeout	38
E63	Stall	38
E66	Overcurrent	39
E67	Inverted phase sequence	39
E70	Undervoltage at electronic supply	39
E71	By-pass contact open	39
E72	Overcurrent before By-pass	39
E74	Current imbalance	39
E75	Power supply frequency out of allowed range	40
E76	Undercurrent before closing By-pass	40
E77	Closed by-pass contact or shorted SCR's	40

III. OTHER MESSAGES

Indication	Meaning
rdy	Soft-Starter ready to be on "ready"
ruP	Soft-Starter on, at acceleration ramp "ramp up"
PASS	Soft-Starter on, at By-Pass "by-pass"
rdo	Soft-Starter on, at deceleration ramp "ramp down"
Exx	Soft-Starter with error
dly	Soft-Starter waiting for time after stop "delay"
G.di	Soft-Starter with general disable "general disable"

1. GENERAL INFORMATION

This manual contains the necessary information for the correct use of the Soft-Starter SSW-07/SSW-08.

It was written to be used by trained or technically qualified people to operate this type of equipment.

2. ABOUT THIS MANUAL

This manual gives the necessary description for the configuration of all the functions and parameters of the Soft-Starter SSW-07/SSW-08. This manual must be used together with the SSW-07/SSW-08 User's Guide.

3. ABOUT THE SSW-07/SSW-08

The Soft-Starter SSW-07/SSW-08 is a high performance product that allows start control of three phase induction motors. This way mechanic shocks in the load and current surges in the power supply can be avoided.

4. ABOUT THE SSW-07/SSW-08 PARAMETER PROGRAMMING

The basic functions of the Soft-Starter SSW-07/SSW-08 can be programmed at the front cover at the SSW-07/SSW-08 (Trimpots and DIP Switch). To program additional functions and/or visualize reading parameters, some accessories must be used, as for example: the Software SuperDrive G2, Serial Communication RS-232 or RS-485, Local or Remote Keypad. For more details see the chapter 7 of the User's Guide and the optionals guides of SSW-07/SSW-08.

NOTE!

For communication with the SSW-07/SSW-08 use the 2nd generation programming software **SuperDrive G2**. The first generation software named SuperDrive is not compatible with this product.

Parameter P219, Parameterization via Keypad/ (Trimpots and DIP Switch), defines the programming origin for the protection and acceleration/deceleration ramps. A Soft-Starter SSW-07/SSW-08 can be programmed via Trimpots and DIP Switches or completely via parameters. See the detailed description of parameters (P219).

Parameters P220, P229, and P230 (Local/Remote Definitions) program the origin of the enable/disable command. Factory default settings enable via digital input. To enable/disable by means of keypad or serial command the settings of P220, P229 and P230 must be changed. See the detailed description of parameters P220, P229 and P230.

The SSW-07/SSW-08 User's Guide has a chapter dedicated to Programming Suggestions. It's important to read this chapter before starting to program the Soft-Starter SSW-07/SSW-08.

5. KEYPAD(HMI) USE

The keypad is a simple interface that allows the operation and the programming of the Soft-Starter. It presents the following functions:

- Indication of the Soft-Starter operational status;
- Indication of the errors;
- Visualization and modification of the adjustable parameters;
- Operation of the soft-Starter (**T** and **G** keys).

The keypad can be used in the following cases:

- If an keypad for commanding, programming and/or visualizing SSW-07/SSW-08 parameters were necessary;
- For installation of the keypad at the cabinet door, commanding panel or at the SSW-07/SSW-08 front cover;
- When the copy function were necessary.

The SSW-07/SSW-08 local or remote keypad presents a 7-segment 4-digit LED display, 4 status LEDs and 8 keys. The figures below show a front view of the remote keypad and of the local keypad.



Figure 5.1 a) - Remote Keypad Front View



Figure 5.1 b) - Local Keypad Front View

5.1. LEDs Display Functions

It shows the parameter number or its content and also fault and status messages.

5.2. Function of the “Local” and “Remote” LEDs

Soft-Starter in Local mode:
Green LED on and red LED off.

Soft-Starter in Remote mode:
Green LED off and red LED on.

5.3. Function of the Direction of Rotation LEDs (Clockwise and Counterclockwise)

Refer to figure below.

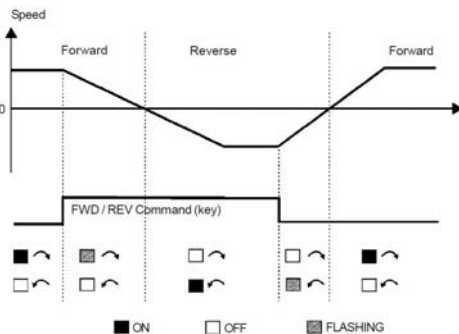










Figure 5.2 - Direction of Rotation (FWD / REV) LEDs

5.4. Basic Functions of the Keys

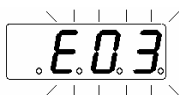
-  - Enables the motor (start);
-  - Disables the motor (stop). Resets the Soft-Starter after the occurrence of errors;
-  - Selects (toggles) the display between the parameter number and its value (position/content);
-  - Increments the parameter number or the parameter value;
-  - Decrements the parameter number or the parameter value;
-  - Selects the origin of the commands between Local or Remote;
-  - Reverses the direction of motor rotation between Forward/Reverse;
-  - Performs the JOG function when pressed. Any Dlx programmed for General Enable must be closed (and the Soft-Starter must be stopped) to enable JOG function.

5.5. Signaling/Indications on the Keypad Display

Soft-Starter states:



Soft-Starter ready to enable the motor



Soft-Starter in an error condition. The error code shows up flashing. In the example we have the E03 indication (phase Loss).



Soft-Starter executing the function "Load parameters with the factory default (P204)".

NOTES!

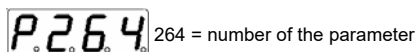
The display also flashes in the following situations, besides the error condition:

- An attempt to change a parameter with an incorrect password (P000 – Access parameter);
- An attempt to change a not allowed parameter. For instance one that cannot be changed with the motor rotating.

5.6. Parameter Viewing/Changing

All the settings of the Soft-Starter can be done through the parameters. The parameters are indicated on the display by means of the letter **P** followed by a number:

Example (P264):



There is a numeric value (content of the parameter) associated to each parameter, which corresponds to the option chosen among the available ones for that parameter.

The values of the parameters define the Soft-Starter programming or the value of a variable (E.g.: current, voltage). In order to carry out the soft-Starter programming one must change the content(s) of the parameter(s).

Example:

ACTION	KEYPAD DISPLAY	DESCRIPTION
To power up a Soft-Starter		Soft-Starter is ready to operate
Press		
Use the and keys		Locate the desired parameter
Press		Numeric value associated to the parameter ⁽²⁾
Use the and keys		Adjust the new desired value ⁽²⁾
Press		(1) (2) (3)

NOTES!

(1) By pressing the key after an adjustment, the last adjusted value is automatically stored in the Soft-Starter nonvolatile memory, being kept until a new modification.

(2) In order to be able to change the value of a parameter, it is necessary to set first P000 = 5. Otherwise it will only be possible to see the parameters, but not changing them. For more details refer to the P000 description.

(3) If the last value programmed in the parameter is not functionally compatible with other parameter values already programmed, an E24 –Programming Error -will be displayed.

Example of programming error:

Programming two digital inputs (Dlx) with the same function. Refer to Table 5.1 for the list of programming errors that will generate an E24 Programming Error.

E24 - Programming Error

Table 5.1 - Incompatibility between Parameters - E24

Two or more parameters between P263 and P265 equal to 2 (LOC/REM);
Two or more parameters between P263 and P265 equal to 4 (Rotation direction);
Two or more parameters between P264 and P265 equal to 7 (Emergency Start);
Two or more parameters between P263 and P265 equal to 8 (Jog);
If programmed Emergency Start with Rotation direction changing, DC Braking or Jog;
(P202 = 3) if the Control Type is programmed to 3 (no function).

6. DETAILED DESCRIPTION OF THE PARAMETERS

The parameters have been grouped by types to make description easier.




Reading Parameters	Variables that can be seen but not changed by the user.
Regulation Parameters	Adjustable values to be used the Soft-Starter functions.
Configuration Parameters	Define the Soft-Starter SSW-07/SSW-08 characteristics, the functions to be carried out, as well as the input/output functions of the control card.
Motor Parameters	The catalog data or motor plate.
Special Functions Parameters	Include the parameters related to the special functions.
Protection Parameters	Parameters related to the action and time levels of the motor protections.

Symbols and definitions used in this chapter:

- (1) Changeable parameters only when the motor is disabled.
- (2) Unchanged parameters at factory default settings (P204=5).
- (3) Changeable parameters only in keypad mode (P219=1). If P219=0 the parameters are read only.

6.1. ACCESS AND READ ONLY PARAMETERS – P000 to P099

Parameter	Range	Description/ Notes
	[Factory Setting] Unit	
P000 Access to parameters	0 to 9999 [0] -	<input checked="" type="checkbox"/> Permits the access to alter the contents of the parameters. <input checked="" type="checkbox"/> Set with factory default values [P200=1 (Active Password)] it is necessary to out P000=5 to change the contents of the parameters.
P001 Motor current %In of SSW-07/ SSW-08	0.0 to 999.9 [-] 0.1%	<input checked="" type="checkbox"/> Indicates the Soft-Starter SSW-07/SSW-08 output current at the nominal current percentage of the Soft-Starter (%In of SSW-07/SSW-08). <input checked="" type="checkbox"/> Accuracy of $\pm 2\%$ for full scale. (Full scale is 5 x In of SSW-07/SSW-08).
P002 Motor current %In of Motor	0.0 to 999.9 [-] 0.1%	<input checked="" type="checkbox"/> Indicates the Soft-Starter SSW-07/SSW-08 output current at the nominal current percentage of the Motor (%In of Motor). <input checked="" type="checkbox"/> Accuracy of $\pm 2\%$ for full scale. (Full scale is 5 x In of SSW-07/SSW-08).
P003 Motor current	0.0 to 6553 [-] 0.1A	<input checked="" type="checkbox"/> Indicates the Soft-Starter SSW-07/SSW-08 output current in Amperes (A). <input checked="" type="checkbox"/> Accuracy of $\pm 2\%$ for full scale. (Full scale is 5 x In of SSW-07/SSW-08).
P005 Power supply frequency	0.0 to 99.9 [-] 0.1Hz	<input checked="" type="checkbox"/> Indicates the power supply frequency in Hertz (Hz). <input checked="" type="checkbox"/> Accuracy of $\pm 5\%$ of the power supply nominal frequency.
P006 Soft-Starter Status	0 to 12 [-] -	<input checked="" type="checkbox"/> Indicates the current status of the Soft-Starter SSW-07/SSW-08. 0 = rdy – Ready to be on “ready”. 2 = Exx – With error. 3 = ruP – Turned on at acceleration ramp “ramp up”. 5 = PASS – On with enabled “by-pass”. 7 = rdo – On at deceleration ramp “ramp down”. 8 = br – Performing braking “braking”. 9 = rEv – Performing reversion of the speed direction “reverting”. 10 = rdo – On at deceleration ramp “ramp down”. 11 = JoG – During Jog “Jog”. 12 = G.di – With “general disable”.
P007 Voltage imposed by the Soft-Starter over the load (%Un)	0 to 100 [-] 1%	<input checked="" type="checkbox"/> Indicates the voltage imposed by Soft-Starter over the load, not taking stator emf generated by the motor into consideration.
P011 Apparent output power	0.0 to 999.9 [-] 0.1kVA	<input checked="" type="checkbox"/> Indicates the apparent power of the average of the three Soft-Starter SSW-07/SSW-08 output phases in kiloVolt Amperes (kVA).
P012 DI1 to DI3 Status	0 to 224 DisplayLED= 0 or 1 [-] -	<input checked="" type="checkbox"/> Indicates the status of the three control card digital inputs (DI1 to DI3). <input checked="" type="checkbox"/> On the keypad display the digital inputs status is shown by numbers 0 = Inactive and 1 = Active in the following order, DI1, DI2 and DI3. The indication is binary and DI1 represents the most significant bit. The 5 less significant bits are not shown on the keypad display. Example: DI1 = Active DI2 = Inactive DI3 = Active

Parameter	Range [Factory Setting] Unit	Description/ Notes
		<p>Which is the equivalent to the sequence of bits: 10100000b. In decimal it corresponds to 160. The binary indication on the keypad is:</p> 
<p>P013 Relay RL1 and RL2 output status</p>	<p>0 to 192 DisplayLED= 0 or 1 [-] -</p>	<p><input checked="" type="checkbox"/> Indicates the status of the 2 control card relay outputs RL1 and RL2).</p> <p><input checked="" type="checkbox"/> On the keypad display the relay output status is shown by numbers (0 = Inactive) and (1= Active), in the following order, RL1 and RL2. The indication is binary and RL1 represents the most significant bit. The 5 less significant bits are not shown on the keypad display.</p> <p>Example: RL1 = Active RL2 = Active</p> <p>Which is the equivalent to the sequence of bits: 11000000b. In decimal it corresponds to 160. The binary indication on the keypad is:</p> 
<p>P014 Last fault occurred</p>	<p>E00 to E77 [-] -</p>	<p><input checked="" type="checkbox"/> Indicates the numbers of the last, second, third and fourth previous faults occurred, respectively.</p> <p><input checked="" type="checkbox"/> Registration systematic: Exy → P014→ P015 P016 → P017</p>
<p>P015 Second fault occurred</p>	<p>E00 to E77 [-] -</p>	
<p>P016 Third fault occurred</p>	<p>E00 to E77 [-] -</p>	
<p>P017 Fourth fault occurred</p>	<p>E00 to E77 [-] -</p>	
<p>P020 Actual Fault</p>	<p>0 to 99 [-] -</p>	<p><input checked="" type="checkbox"/> It indicates if any fault is active.</p> <p> NOTE! Faults related to communication, E28, are not indicated in P020.</p>
<p>P023 Software Version</p>	<p>X.XX [-] -</p>	<p><input checked="" type="checkbox"/> Indicates the Software version in the microcontroller memory (DSP) on the control board.</p>

Parameter	Range [Factory Setting] Unit	Description/ Notes
P030 Phase R current	0.0 to 6553 [-] 0.1A	<input checked="" type="checkbox"/> Indicates the output currents of phases R, S and T in Amperes. The True RMS current is indicated individually for each phase. <input checked="" type="checkbox"/> Accuracy of $\pm 2\%$ for the full scale. (Full scale is $5 \times \ln$ of SSW-07/SSW-08).
P031 Phase S current	0.0 to 6553 [-] 0.1A	
P032 Phase T current	0.0 to 6553 [-] 0.1A	
P050 Motor thermal protection status	0 to 250 [-] 1%	<input checked="" type="checkbox"/> Indication of the state of motor thermal protection in a scale of 0% to 250%. Being 250 the thermal protection functioning point of the motor, indicating an error. <input checked="" type="checkbox"/> The value indicated in this parameter depends on the motor working condition and how long it has been in this condition, for example: stopped, starting or in full operation. The thermal class selected and the nominal power of the motor also influence in this parameter. <input checked="" type="checkbox"/> Only a value of approximately 160 can be read if the motor is operating in full load for over 2 hours with a current equal to the nominal current times the service factor ($\ln \times S.F. @ 2h$).
P081 Heatsink temperature	10.0 to 110.0 [-] 0.1°C	<input checked="" type="checkbox"/> Indicates the SCR heatsink temperature in °C. <input checked="" type="checkbox"/> Range: 10.0°C (50.0°F) to 110.0°C (230.0°F).
P090 to P096 Parameters Regarding the DeviceNet Communication	-	<input checked="" type="checkbox"/> Parameters for the DeviceNet interface configuration and operation. In order to get a detailed description, refer to the DeviceNet Communication Manual, supplied in electronic format on the CD-ROM that comes with the product.

6.2. REGULATION PARAMETERS - P100 to P199

P101 Initial voltage (%Un)	30 to 90 [50] 1% Un do Motor	<input checked="" type="checkbox"/> Used in the control by Voltage Ramp and Pump Controls. <input checked="" type="checkbox"/> Sets the initial value of nominal voltage (%Un) that will be applied to the motor as in figure 6.1. <input checked="" type="checkbox"/> This parameter must be set to the minimum value to get the motor rotating. <input checked="" type="checkbox"/> The initial voltage is applied at a greater or equal to 0.5s after the Soft-Starter receives the command to start on the motor. This is the delay time for the power supply isolation contactor to close the contacts.
--------------------------------------	--------------------------------------	---

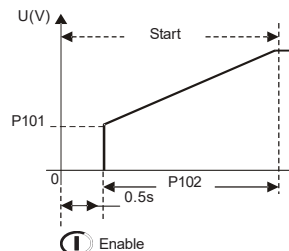


Figure 6.1 - Initial time in a start with voltage ramp

Parameter	Range [Factory Setting] Unit	Description/ Notes
P102 Acceleration ramp time	1 to 999 [20] 1s	<input checked="" type="checkbox"/> When the Soft-Starter is programmed with Voltage Ramp, Pump Control or Direct Online control, this is the voltage increment ramp time, as seen in the figure 6.2.

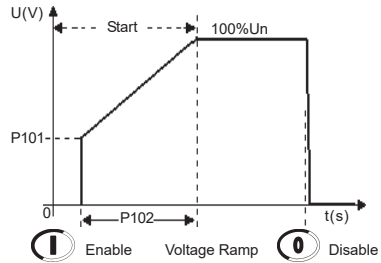


Figure 6.2 - Acceleration ramp by voltage ramp

When the Soft-Starter is programmed with Current Limitation or Current Ramp control, this time serves as the maximum starting time, operating as a protection against blocked rotor.

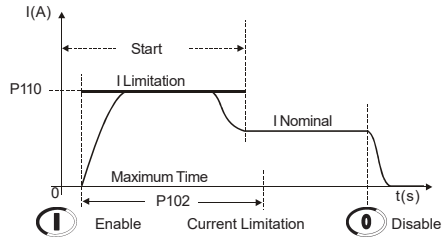


Figure 6.3 - Current limitation acceleration ramp

NOTE!

The time programmed at P102 is not the exact motor acceleration time, but, the voltage ramp time or the maximum starting time. The motor acceleration time will depend on the motor characteristics as well as the load.

P103 Deceleration voltage step (% Un)	100 = Inactive 99 to 60 [100] 1%	<input checked="" type="checkbox"/> Used in applications with hydraulic pumps. <input checked="" type="checkbox"/> Sets the nominal voltage value (%Un) that will be applied to the motor immediately after the Soft-Starter receives the deceleration by ramp command.
--	---	--

NOTE!

For this function to turn on a deceleration ramp time must be programmed.


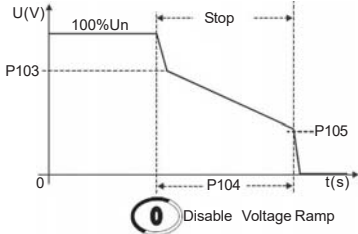
Parameter	Range [Factory Setting] Unit	Description/ Notes
P104 ⁽³⁾ Deceleration ramp time	0 = Inactive 1 to 240 [0] 1s	<input checked="" type="checkbox"/> Used in applications with hydraulic pumps. <input checked="" type="checkbox"/> Enables and sets the voltage decrement ramp time.  NOTE! This function is used to lengthen the normal deceleration time of a load and not to force a lower time than the one imposed by the load.
P105 End Deceleration Voltage	30 to 55 [30] 1%	<input checked="" type="checkbox"/> Used in hydraulic pump applications. <input checked="" type="checkbox"/> Sets the nominal voltage (%Un), which will be applied to the motor at the end of the deceleration ramp. <input checked="" type="checkbox"/> For more details about the programming and use, refer to Pump Control at P202.
		
P110 ⁽³⁾ Start by current limitation (%In of the Soft-Starter)	30 to 500 [300] 1%In of the Soft-Starter	<input checked="" type="checkbox"/> Defines the maximum current limit during a motor start as a percentage of the Soft-Started nominal current. <input checked="" type="checkbox"/> If the current limit is reached during the motor start, the Soft-Starter will maintain the current of this limit until the motor reaches the end of the start. <input checked="" type="checkbox"/> If the current limit is not reached, the motor will start immediately. <input checked="" type="checkbox"/> To select the Control by Current Limitation, see P202.
P111 Initial Current for Current Ramp (%In of the Soft-Starter)	30 to 500 [150] 1% In of the Soft-Starter	<input checked="" type="checkbox"/> Used for the control by Current Ramp, P202=4. <input checked="" type="checkbox"/> Allows a current limit ramp to be programmed to help in the starting of loads that have a lower or higher starting torque. <input checked="" type="checkbox"/> The initial value of the current limit is shown by P111, the final value is shown by P110 and the time is shown by P112.

Figure 6.4 - Deceleration ramp by voltage decrement

Parameter	Range [Factory Setting] Unit	Description/ Notes
P112 Time for the Current Ramp (% de P102)	1 to 99 [20] 1% of P102	<input checked="" type="checkbox"/> Used for the control by Current Ramp, P202=4. <input checked="" type="checkbox"/> It enables programming the time, in percent of P102, for the end Current Ramp. <input checked="" type="checkbox"/> After the time, programmed at P112, has elapsed, it starts operation by Current Limit, given by P110.

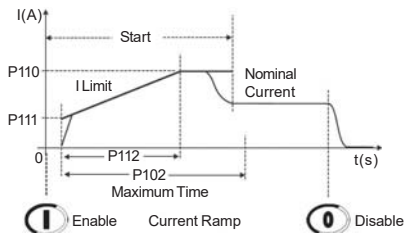


Figure 6.5 a) - Current Limit by Current Ramp during Starting

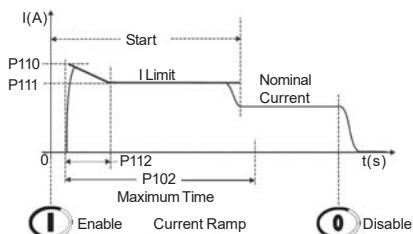


Figure 6.5 b) - Current Limit by Current Ramp during Starting

6.3. CONFIGURATION PARAMETERS - P200 to P299

P200 The password is (activate/deactivate password)	0 or 1 [1] -	Table 6.1 - Enabling the password	
		P200	Action
		0 (Inactive)	Allows the parameter contents to be altered independent of P000.
		1 (Active)	Only allows parameter content alterations when P000 is equal to the password value.

The value of the password is P000=5.

Parameter	Range [Factory Setting] Unit	Description/ Notes														
P202 Type of control	0 to 5 [0=Voltage Ramp] -	<p style="text-align: center;"><i>Table 6.2 - Type of control</i></p> <table border="1" style="margin-left: auto; margin-right: auto;"> <thead> <tr> <th>P202</th> <th>Description</th> </tr> </thead> <tbody> <tr> <td>0</td> <td>Voltage ramp</td> </tr> <tr> <td>1</td> <td>Current limitation</td> </tr> <tr> <td>2</td> <td>Pump control</td> </tr> <tr> <td>3</td> <td>No function</td> </tr> <tr> <td>4</td> <td>Current ramp</td> </tr> <tr> <td>5</td> <td>Direct online Start (DOL)</td> </tr> </tbody> </table> <p><input checked="" type="checkbox"/> Soft-Starter SSW-07/SSW-08 has five types of starting controls to best adapt itself to the needs of its application.</p> <p>Starting with voltage ramp: This is the most commonly used method. The Soft-Starter imposes the voltage on the motor without any kind of voltage or current feedback applied to the motor. This is applied to loads with lower initial torques or quadratic torques. This kind of control can be used as an initial working test.</p> <p>Starting by current limitation: The maximum current level is maintained during the start, being set according to the needs of the application. Applied to loads with higher initial torques or constant torques. This type of control is used to adapt the start to the capacity limits of the supply network.</p> <p>Start by Pump Control: This type of control provides the required torque for starting and stopping hydraulic centrifugal pumps smoothly. It has a special algorithm for application in centrifugal pumps, where loads with quadratic torques are present. This special algorithm aims to minimize pressure overshoots in the hydraulic piping, which can result in breakdown or excessive pump wearing.</p> <p>Start by Current Ramp: The maximum current level is limited during the start process, however higher or lower current limits can be set during the beginning of the start sequence. It can substitute the kick start functions for loads with higher initial torques. This type of control is used for loads with lower or higher initial torques. This type of control is used to match the start process to the limits of the power supply capacity.</p> <p>Direct online start (DOL): The Soft-Starter imposes 100% of voltage on the motor without any kind of voltage or current feedback applied to the motor. This method is applied only in special cases, where is required 100% of voltage on the motor during the motor starting.</p>	P202	Description	0	Voltage ramp	1	Current limitation	2	Pump control	3	No function	4	Current ramp	5	Direct online Start (DOL)
P202	Description															
0	Voltage ramp															
1	Current limitation															
2	Pump control															
3	No function															
4	Current ramp															
5	Direct online Start (DOL)															

Parameter	Range [Factory Setting] Unit	Description/ Notes								
P203 Fan Control	0 to 2 [2] -	<ul style="list-style-type: none"> <input checked="" type="checkbox"/> P203 defines the operation mode of the heatsink cooling fan. <input checked="" type="checkbox"/> The ventilation kit is an option. Refer to the Optional Devices Chapter on the User Manual. <input checked="" type="checkbox"/> The SSW-07/SSW-08 from 17 to 30A models do not need the ventilation kit. <input checked="" type="checkbox"/> When in the “fan controlled by software” mode (P203 = 2), the fan is switched ON when the SCR’s are conducting or when the heatsink temperature is higher than 65°C. The fan is switched OFF when the SCR’s are not conducting and the temperature is lower than 55°C. <p style="text-align: center;"><i>Table 6.3 - Options for the fan control</i></p> <table border="1" style="margin-left: auto; margin-right: auto;"> <thead> <tr> <th>P203</th> <th>Action</th> </tr> </thead> <tbody> <tr> <td>0</td> <td>The Fan is always OFF</td> </tr> <tr> <td>1</td> <td>The fan is always ON</td> </tr> <tr> <td>2</td> <td>The fan is controlled by software</td> </tr> </tbody> </table>	P203	Action	0	The Fan is always OFF	1	The fan is always ON	2	The fan is controlled by software
P203	Action									
0	The Fan is always OFF									
1	The fan is always ON									
2	The fan is controlled by software									
P204 ⁽¹⁾ Loads parameters with factory default values	0 to 5 [0] -	<ul style="list-style-type: none"> <input checked="" type="checkbox"/> Reprograms all the parameters to the factory default values, making P204=5. <input checked="" type="checkbox"/> Parameters P000, P295, P308 and P312 are not changed when P204=5 (factory default). <p style="text-align: center;"><i>Table 6.4 - Loads parameters with factory default</i></p> <table border="1" style="margin-left: auto; margin-right: auto;"> <thead> <tr> <th>P204</th> <th>Action</th> </tr> </thead> <tbody> <tr> <td>0 to 4</td> <td>No function</td> </tr> <tr> <td>5</td> <td>Loads factory default</td> </tr> </tbody> </table>	P204	Action	0 to 4	No function	5	Loads factory default		
P204	Action									
0 to 4	No function									
5	Loads factory default									
P205 Selection of the reading parameter	0 to 999 [1] -	<ul style="list-style-type: none"> <input checked="" type="checkbox"/> Selects which parameters will be shown on the display after the Soft-Starter is energized. <input checked="" type="checkbox"/> The value programmed at P205 is equal to the parameter number that will be shown on the display after it is energized. <input checked="" type="checkbox"/> If the programmed value corresponds to a non-existent parameter, the adopted value will be 1=P001. 								
P206 Auto-Reset time	3 to 1200 [900] 1s	<ul style="list-style-type: none"> <input checked="" type="checkbox"/> When an error occurs, except for E04, E10, E19, E24, E28, E3x, E67 and E77, the Soft-Starter will reset automatically, after passing the time given by P206. <input checked="" type="checkbox"/> After the auto-reset, if the same error occurs again three times consecutively, the auto-reset function will be inhibited. If an error appears again up to 30 seconds after the auto-reset is executed, it is considered to be a reoccurrence, <input checked="" type="checkbox"/> Therefore, if an error occurs four times consecutively, this error will continue being indicated (and the Soft-Starter will continue to be disabled) permanently. <p> NOTE!</p> <p>For Electronic Motor Overload and Power Overtemperature there is a specific algorithm for the automatic reset time.</p>								
P207 ⁽³⁾ Auto-Reset	0 to 1 [0=Inactive]	<p style="text-align: center;"><i>Table 6.5 - Auto-Reset Selection</i></p> <table border="1" style="margin-left: auto; margin-right: auto;"> <thead> <tr> <th>P207</th> <th>Description</th> </tr> </thead> <tbody> <tr> <td>0</td> <td>Inactive</td> </tr> <tr> <td>1</td> <td>Active</td> </tr> </tbody> </table>	P207	Description	0	Inactive	1	Active		
P207	Description									
0	Inactive									
1	Active									

Parameter	Range [Factory Setting] Unit	Description/ Observation
P215 ⁽¹⁾ Copy function	0 to 2 [0] -	<input checked="" type="checkbox"/> The copy function is used to transfer the parameter contents of a Soft-Starter.

Table 6.6 - Copy function

P215	Action	Explanation
0	Inactive	-
1	Copy (SSW → Keypad)	Transfers the present parameter contents of the Soft-Starter to the non-volatile memory of the keypad (EEPROM). The present parameters of the Soft-Starter remain unaltered.
2	Paste (Keypad → SSW)	Transfers the contents of the non-volatile memory of the keypad (EEPROM) to the present parameters of the Soft-Starter.

Procedure to be used to copy the parameterization of Soft-Starter A to Soft-Starter B:

1. Connect the keypad to the Soft-Starter from which one wishes to copy the parameters (Soft-Starter A – source).
2. Set P215=1 (copy) to transfer the parameters of Soft-Starter A to the keypad. Press the **PROG** key .

While the copy function is being processed, “**COPY**” appears on the display. P215 returns automatically to 0 (Inactive) when the transfer is concluded.

3. Remove the keypad from Soft-Starter (A).
4. Connect this same keypad to the Soft-Starter which one wishes to transfer the parameters (Soft-Starter B – destiny).
5. Set P215=2 (paste) to transfer the contents of the non-volatile memory of the keypad (EEPROM- containing the parameters of Soft-Starter A) to Soft-Starter B. Press the **PROG** key. While the keypad is processing the paste function, “**PAST**”, an abbreviation of paste, will appear on the display. When P215 returns to 0 and is reset, the transfer of the parameters will be concluded. From this moment on, Soft-Starters A and B will have the same parameter contents.

Please remember:

If Soft-Starters A and B command different motors, please check the motor parameters of Soft-Starter A and B.

For copying the parameter contents of Soft-Starter A to other Soft-Starters, repeat procedures 4 and 5 above.

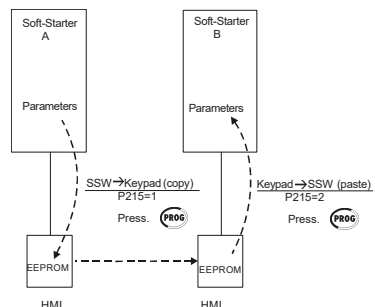




Figure 6.6 - Copy of the parameters from “Soft-Starter A” to “Soft-Starter B”

Parameter	Range [Factory Setting] Unit	Description/ Notes																														
		<p> NOTE!</p> <p>If the Keypad has saved parameters of a “different version” than that installed in Soft-Starter SSW-07/SSW-08 to which it is trying to copy the parameters, the operation will not be executed and Soft-Starter SSW-07/SSW-08 will display error E10 (Error: Copy Function not permitted). “Different Version” are those that are different in “x” or “y”, supposing that the numbering of Software Versions is described as Vx.yz.</p>																														
<p>P219 ⁽¹⁾ Parameterization via keypad / (Trim pots and DIP Switch)</p>	<p>0 to 2 [0=Trim pots and DIP Switch] -</p>	<p><input checked="" type="checkbox"/> Defines the programming mode of the following parameters: P101, P102, P104, P110, P202, P207, P401, P520, P521, P611, P613, P617, P620 and P640. These parameters are marked in the quick parameter reference with the observation ⁽³⁾.</p> <p>0 – “(Trim pot and DIP Switch) Mode”, programming of the parameters mentioned above is done through the Trim pots and DIP Switches. The parameters function as reading parameters, only showing the programmed values through Trim pots and DIP Switches. The values programmed through serial communication are not used.</p> <p>1 – “Keypad Mode”, programming of the parameters mentioned above is done through serial communication or keypad. The values set in the Trim pots and DIP Switches are not used.</p> <p>2 - “P202=2 / Trim pot and DIP”, use this mode only when the pump control is required and there is not available a Keypad or serial communication. In this mode, the parameterization is done through Trim pots and DIP Switch. The control type is set to pump control, ignoring the setting of the DIP Switch “Voltage Ramp / Current Limit”. The item 5.1.4 of the User’s Manual, explain how to program P219 without Keypad or serial communication.</p>																														
<p>P220 ⁽¹⁾ LOCAL/REMOTE Source Selection</p>	<p>0 to 8 [3 = Keypad (Remote Default)] -</p>	<p><input checked="" type="checkbox"/> Defines the supply origin of the command that will select between the Local and Remote situations.</p> <p style="text-align: center;"><i>Table 6.7 – Local/remote origin</i></p> <table border="1" style="width: 100%; border-collapse: collapse;"> <thead> <tr> <th>P220</th> <th>Local/Remote Selection</th> <th>Default Situation</th> </tr> </thead> <tbody> <tr> <td>0</td> <td>Always Local Situation</td> <td>Local</td> </tr> <tr> <td>1</td> <td>Always Remote Situation</td> <td>Remote</td> </tr> <tr> <td>2</td> <td>“Loc/Rem” Keypad</td> <td>Local</td> </tr> <tr> <td>3</td> <td>“Loc/Rem” Keypad</td> <td>Remote</td> </tr> <tr> <td>4</td> <td>Digital inputs DI1 to DI3</td> <td>Status DIx</td> </tr> <tr> <td>5</td> <td>Serial Communication</td> <td>Local</td> </tr> <tr> <td>6</td> <td>Serial Communication</td> <td>Remote</td> </tr> <tr> <td>7</td> <td>Fieldbus</td> <td>Local</td> </tr> <tr> <td>8</td> <td>Fieldbus</td> <td>Remote</td> </tr> </tbody> </table>	P220	Local/Remote Selection	Default Situation	0	Always Local Situation	Local	1	Always Remote Situation	Remote	2	“Loc/Rem” Keypad	Local	3	“Loc/Rem” Keypad	Remote	4	Digital inputs DI1 to DI3	Status DIx	5	Serial Communication	Local	6	Serial Communication	Remote	7	Fieldbus	Local	8	Fieldbus	Remote
P220	Local/Remote Selection	Default Situation																														
0	Always Local Situation	Local																														
1	Always Remote Situation	Remote																														
2	“Loc/Rem” Keypad	Local																														
3	“Loc/Rem” Keypad	Remote																														
4	Digital inputs DI1 to DI3	Status DIx																														
5	Serial Communication	Local																														
6	Serial Communication	Remote																														
7	Fieldbus	Local																														
8	Fieldbus	Remote																														
<p>P229 ⁽¹⁾ Command selection – local situation</p> <p>P230 ⁽¹⁾ Command selection – remote situation</p>	<p>0 to 3 [0 = Keypad] -</p> <p>0 to 3 [1 = Terminals] -</p>	<p><input checked="" type="checkbox"/> Default Situation = When the Soft-Starter is energized (initialization).</p> <p><input checked="" type="checkbox"/> Defines the origin of the on and off commands of the Soft-Starter.</p> <p style="text-align: center;"><i>Table 6.8 – Origin of the motor on/off</i></p> <table border="1" style="width: 100%; border-collapse: collapse;"> <thead> <tr> <th>P229/P230</th> <th>Origin of the Commands</th> </tr> </thead> <tbody> <tr> <td>0</td> <td>Keypad</td> </tr> <tr> <td>1</td> <td>Dlx Digital Inputs</td> </tr> <tr> <td>2</td> <td>Serial Communication</td> </tr> <tr> <td>3</td> <td>Fieldbus</td> </tr> </tbody> </table>	P229/P230	Origin of the Commands	0	Keypad	1	Dlx Digital Inputs	2	Serial Communication	3	Fieldbus																				
P229/P230	Origin of the Commands																															
0	Keypad																															
1	Dlx Digital Inputs																															
2	Serial Communication																															
3	Fieldbus																															

Parameter	Range [Factory Setting] Unit	Description/ Notes
P263 DI1 Input Function	0 to 8 [1 = Start/Stop (Two wires) or Start (Three wires)] -	<input checked="" type="checkbox"/> Check the options available on table 6.8. <input checked="" type="checkbox"/> The status of the digital inputs can be monitored in parameter P012. <input checked="" type="checkbox"/> “Enable/Disable” = DI1 input is Closed/Open, respectively. Requires the programming of P263 = 1, P264 ≠ 1 (Enable/Disable with two wires) and the programming of the Enable/Disable commands by digital input.
P264 DI2 Input function	0 to 8 [6 = Reset] -	<input checked="" type="checkbox"/> “Start/Stop” = When programming P263 = 1 and P264 = 1 (Start/Stop with Three Wires), inputs DI1 and DI2 become DI1 = Start and DI2 = Stop. Use push button, DI1 Normally Open and DI2 Normally Closed. Requires the programming of the Enable/Disable commands by digital input.
P265 DI3 Input function	0 to 8 [6 = Reset] -	<input checked="" type="checkbox"/> “Local/Remote” = The digital input is Open/Closed, respectively. Do not program more than one digital input for this function. <input checked="" type="checkbox"/> “Error Reset” = Resets the errors when the digital input is closed. Use only push button. When the input remains closed, the error reset will not act. <input checked="" type="checkbox"/> “No External Error” = There is no external fault if the digital input is closed. <input checked="" type="checkbox"/> “General Enable/General Disable” = The digital input is Closed/Open, respectively. This function allows the motor to turn on when it is on General Enable and to turn off the motor without a deceleration ramp when the General Disable command is given. There is no need to program general enable to turn on the motor via digital input. If general enable is programmed by digital input, then it must be closed to allow the motor to turn on, even if the commands are not by digital inputs. <input checked="" type="checkbox"/> “Rotation Direction” = Digital input open K1 "on" and K2 "off", digital input closed K1 "off" and K2 "on". This enables the change control of the rotation direction through digital input. Do not program more than one digital input for this function. <input checked="" type="checkbox"/> “Jog” = It is possible to enable slow speed with Jog via Digital Input when it is closed. Use a push-button only. Do not program more than one digital input for this function. <input checked="" type="checkbox"/> “Brake Off” = It is possible to disable the braking methods when the digital input is open, for extra safety, monitor real motor stand still and disable the braking immediately. If more than one digital input is programmed for this function, any one which is opened disables the braking immediately <input checked="" type="checkbox"/> “Emergency Start” = It makes possible start and stop the motor during any error action, not respecting the protections of Soft-Starter or the motor. This option is used for the hydraulical pumps of protection against fire.

Parameter	Range [Factory Setting] Unit	Description/ Notes																																																
		<p>NOTE! The Emergency Start only must be used in emergency case, otherwise the Soft-Starter or the motor may be damaged.</p> <p><i>Table 6.9 – Digital input functions</i></p> <table border="1"> <thead> <tr> <th>Dix Parameter Function</th> <th>P263 (DI1)</th> <th>P264 (DI2)</th> <th>P265 (DI3)</th> </tr> </thead> <tbody> <tr> <td>No Function</td> <td>0</td> <td>0</td> <td>0</td> </tr> <tr> <td>Enable/Disable or Start (two or Three wires)</td> <td>1</td> <td>-</td> <td>-</td> </tr> <tr> <td>Stop (Three wires)</td> <td>-</td> <td>1</td> <td>-</td> </tr> <tr> <td>General Enable</td> <td>-</td> <td>-</td> <td>1</td> </tr> <tr> <td>Local/Remote</td> <td>2</td> <td>2</td> <td>2</td> </tr> <tr> <td>No External Fault</td> <td>3</td> <td>3</td> <td>3</td> </tr> <tr> <td>Rotation Direction</td> <td>4</td> <td>4</td> <td>4</td> </tr> <tr> <td>Brake Off</td> <td>5</td> <td>5</td> <td>5</td> </tr> <tr> <td>Reset</td> <td>6</td> <td>6</td> <td>6</td> </tr> <tr> <td>Emergency Start</td> <td>-</td> <td>7</td> <td>7</td> </tr> <tr> <td>Jog</td> <td>8</td> <td>8</td> <td>8</td> </tr> </tbody> </table>	Dix Parameter Function	P263 (DI1)	P264 (DI2)	P265 (DI3)	No Function	0	0	0	Enable/Disable or Start (two or Three wires)	1	-	-	Stop (Three wires)	-	1	-	General Enable	-	-	1	Local/Remote	2	2	2	No External Fault	3	3	3	Rotation Direction	4	4	4	Brake Off	5	5	5	Reset	6	6	6	Emergency Start	-	7	7	Jog	8	8	8
Dix Parameter Function	P263 (DI1)	P264 (DI2)	P265 (DI3)																																															
No Function	0	0	0																																															
Enable/Disable or Start (two or Three wires)	1	-	-																																															
Stop (Three wires)	-	1	-																																															
General Enable	-	-	1																																															
Local/Remote	2	2	2																																															
No External Fault	3	3	3																																															
Rotation Direction	4	4	4																																															
Brake Off	5	5	5																																															
Reset	6	6	6																																															
Emergency Start	-	7	7																																															
Jog	8	8	8																																															
<p>P277 RL1 Relay function</p>	<p>0 to 13 [1= Running] -</p>	<p><input checked="" type="checkbox"/> Check the options available on table 6.9.</p> <p><input checked="" type="checkbox"/> The status of the relay outputs can be monitored in parameter P013.</p> <p><input checked="" type="checkbox"/> When the function programmed for the relay output is true, the relay output will be turned on.</p>																																																
<p>P278 RL2 Relay function</p>	<p>0 to 13 [2= Full Voltage] -</p>	<p><input checked="" type="checkbox"/> “No Function” = Relay outputs always turned off.</p> <p><input checked="" type="checkbox"/> “Running” = The output is turned on when the Soft-Starter receives an enabled signal. The output is turned off when the Soft-Starter receives the turn off command, or at the end of the deceleration ramp, if it is programmed.</p> <p><input checked="" type="checkbox"/> “Full Voltage” = The output is turned on when the Soft-Starter reaches 100% Un and turned off when it receives an off command.</p> <p><input checked="" type="checkbox"/> “FWD/REV - K1” = this operation is similar to the "Running", but it must be enabled with forward motor direction of rotation. See the recommended setup at the User's Manual for more information.</p> <p><input checked="" type="checkbox"/> “FWD/REV - K2” = this operation is similar to the "Running", but it must be enabled with reverse motor direction of rotation. See the recommended setup at the User's Manual for more information.</p> <p><input checked="" type="checkbox"/> “DC-Braking” = the output will be enabled while the DC-Braking is active. See P501 and the recommended setup at the User's Manual for more information.</p> <p><input checked="" type="checkbox"/> “No Fault” = The output is enabled, if the Soft-Starter is not disabled due to any error.</p> <p><input checked="" type="checkbox"/> “Fault” = The output is enabled, if the Soft-Starter is disabled due to any error.</p> <p><input checked="" type="checkbox"/> “Serial” = See the Serial Communication Manual.</p> <p><input checked="" type="checkbox"/> “Shunt Trip” = When one of these errors are active, E03, E19, E66, E72 or E77, the output is turned on.</p>																																																



Parameter	Range [Factory Setting] Unit	Description/ Notes																																																																
		<p align="center"><i>Table 6.10 – Relay output functions</i></p> <table border="1"> <thead> <tr> <th>Function</th> <th>RLx Parameter</th> <th>P277 (RL1)</th> <th>P278 (RL2)</th> </tr> </thead> <tbody> <tr><td>No Function</td><td></td><td>0</td><td>0</td></tr> <tr><td>Running</td><td></td><td>1</td><td>1</td></tr> <tr><td>Full Voltage</td><td></td><td>2</td><td>2</td></tr> <tr><td>No Function</td><td></td><td>3</td><td>3</td></tr> <tr><td>FWD/REV - K1</td><td></td><td>4</td><td>-</td></tr> <tr><td>FWD/REV - K2</td><td></td><td>-</td><td>4</td></tr> <tr><td>DC-Braking</td><td></td><td>5</td><td>5</td></tr> <tr><td>No Fault</td><td></td><td>6</td><td>6</td></tr> <tr><td>Fault</td><td></td><td>7</td><td>7</td></tr> <tr><td>No Function</td><td></td><td>8</td><td>8</td></tr> <tr><td>Serial</td><td></td><td>9</td><td>9</td></tr> <tr><td>No Function</td><td></td><td>10</td><td>10</td></tr> <tr><td>No Function</td><td></td><td>11</td><td>11</td></tr> <tr><td>No Function</td><td></td><td>12</td><td>12</td></tr> <tr><td>Shunt Trip</td><td></td><td>13</td><td>13</td></tr> </tbody> </table>	Function	RLx Parameter	P277 (RL1)	P278 (RL2)	No Function		0	0	Running		1	1	Full Voltage		2	2	No Function		3	3	FWD/REV - K1		4	-	FWD/REV - K2		-	4	DC-Braking		5	5	No Fault		6	6	Fault		7	7	No Function		8	8	Serial		9	9	No Function		10	10	No Function		11	11	No Function		12	12	Shunt Trip		13	13
Function	RLx Parameter	P277 (RL1)	P278 (RL2)																																																															
No Function		0	0																																																															
Running		1	1																																																															
Full Voltage		2	2																																																															
No Function		3	3																																																															
FWD/REV - K1		4	-																																																															
FWD/REV - K2		-	4																																																															
DC-Braking		5	5																																																															
No Fault		6	6																																																															
Fault		7	7																																																															
No Function		8	8																																																															
Serial		9	9																																																															
No Function		10	10																																																															
No Function		11	11																																																															
No Function		12	12																																																															
Shunt Trip		13	13																																																															
P295 ⁽¹⁾⁽²⁾ Nominal current	0 to 13 [According to the nominal current of the Soft-Starter SSW-07/ SSW-08] A	<p align="center"><i>Table 6.11 – Nominal current configuration</i></p> <table border="1"> <thead> <tr> <th>P295</th> <th>Nominal Current (A)</th> </tr> </thead> <tbody> <tr><td>0</td><td>1.7</td></tr> <tr><td>1</td><td>17</td></tr> <tr><td>2</td><td>24</td></tr> <tr><td>3</td><td>30</td></tr> <tr><td>4</td><td>45</td></tr> <tr><td>5</td><td>61</td></tr> <tr><td>6</td><td>85</td></tr> <tr><td>7</td><td>130</td></tr> <tr><td>8</td><td>171</td></tr> <tr><td>9</td><td>200</td></tr> <tr><td>10</td><td>255</td></tr> <tr><td>11</td><td>312</td></tr> <tr><td>12</td><td>365</td></tr> <tr><td>13</td><td>412</td></tr> </tbody> </table> <p align="center"> ATTENTION!</p> <p>Never program this parameter with a current value that is not exactly like the one for your Soft-Starter SSW-07/SSW-08 model. If this parameter is programmed incorrectly it can damage the Soft-Starter.</p>	P295	Nominal Current (A)	0	1.7	1	17	2	24	3	30	4	45	5	61	6	85	7	130	8	171	9	200	10	255	11	312	12	365	13	412																																		
P295	Nominal Current (A)																																																																	
0	1.7																																																																	
1	17																																																																	
2	24																																																																	
3	30																																																																	
4	45																																																																	
5	61																																																																	
6	85																																																																	
7	130																																																																	
8	171																																																																	
9	200																																																																	
10	255																																																																	
11	312																																																																	
12	365																																																																	
13	412																																																																	
P308 ⁽¹⁾⁽²⁾ Soft-Starter address	1 to 247 [1] -	<input checked="" type="checkbox"/> Defines the Soft-Starter address in the Modbus-RTU serial communication network. <input checked="" type="checkbox"/> For more details, see the Soft-Starter SSW-07/SSW-08 Serial Communication Manual.																																																																

6.4. COMMUNICATION PARAMETERS – P300 to P399

P312 ⁽¹⁾⁽²⁾ Type of protocol and transmission rate of the serial communication	1 to 9 [1=Modbus-RTU (9600bps, no parity)] -	<p align="center"><i>Table 6.12 - Modbus-RTU standard and protocol</i></p> <table border="1"> <thead> <tr> <th>P312</th> <th>Action</th> </tr> </thead> <tbody> <tr><td>1</td><td>Modbus-RTU (9600bps, no parity)</td></tr> <tr><td>2</td><td>Modbus-RTU (9600bps, odd parity)</td></tr> <tr><td>3</td><td>Modbus-RTU (9600bps, even parity)</td></tr> <tr><td>4</td><td>Modbus-RTU (19200bps, no parity)</td></tr> <tr><td>5</td><td>Modbus-RTU (19200bps, odd parity)</td></tr> <tr><td>6</td><td>Modbus-RTU (19200bps, even parity)</td></tr> <tr><td>7</td><td>Modbus-RTU (38400bps, no parity)</td></tr> <tr><td>8</td><td>Modbus-RTU (38400bps, odd parity)</td></tr> <tr><td>9</td><td>Modbus-RTU (38400bps, even parity)</td></tr> </tbody> </table>	P312	Action	1	Modbus-RTU (9600bps, no parity)	2	Modbus-RTU (9600bps, odd parity)	3	Modbus-RTU (9600bps, even parity)	4	Modbus-RTU (19200bps, no parity)	5	Modbus-RTU (19200bps, odd parity)	6	Modbus-RTU (19200bps, even parity)	7	Modbus-RTU (38400bps, no parity)	8	Modbus-RTU (38400bps, odd parity)	9	Modbus-RTU (38400bps, even parity)
P312	Action																					
1	Modbus-RTU (9600bps, no parity)																					
2	Modbus-RTU (9600bps, odd parity)																					
3	Modbus-RTU (9600bps, even parity)																					
4	Modbus-RTU (19200bps, no parity)																					
5	Modbus-RTU (19200bps, odd parity)																					
6	Modbus-RTU (19200bps, even parity)																					
7	Modbus-RTU (38400bps, no parity)																					
8	Modbus-RTU (38400bps, odd parity)																					
9	Modbus-RTU (38400bps, even parity)																					

Parameter	Range [Factory Setting] Unit	Description/ Notes										
		<ul style="list-style-type: none"> <input checked="" type="checkbox"/> Defines the protocol standards of the Modbus-RTU serial communication. <input checked="" type="checkbox"/> For more details, see the Soft-Starter SSW-07/SSW-08 Serial Communication Manual. 										
P313 Serial communication error action (E28)	0 to 3 [1=Disable] -	<p><i>Table 6.13 – Serial communication error action</i></p> <table border="1" style="margin-left: auto; margin-right: auto;"> <thead> <tr> <th>P313</th> <th>Action</th> </tr> </thead> <tbody> <tr> <td>0</td> <td>Inactive</td> </tr> <tr> <td>1</td> <td>Disable</td> </tr> <tr> <td>2</td> <td>General Disable</td> </tr> <tr> <td>3</td> <td>Change to Local</td> </tr> </tbody> </table> <ul style="list-style-type: none"> <input checked="" type="checkbox"/> Defines the action to be taken if one of the errors related to the serial communication occurs. <input checked="" type="checkbox"/> For more details, see the Soft-Starter SSW-07/SSW-08 Serial Communication Manual. <p>NOTES!</p> <ul style="list-style-type: none"> <input checked="" type="checkbox"/> The Remote/Local keypad exchanges data with the microprocessor through serial communication, therefore this function is also valid for the communication between the keypad and the Soft-Starter. <input checked="" type="checkbox"/> If the serial communication is not being used, this parameter must remain at 0 (Inactive). 	P313	Action	0	Inactive	1	Disable	2	General Disable	3	Change to Local
P313	Action											
0	Inactive											
1	Disable											
2	General Disable											
3	Change to Local											
P314 ⁽¹⁾ Serial communication verification time	0 to 999 [0=Inactive] 1s	<ul style="list-style-type: none"> <input checked="" type="checkbox"/> If the Soft-Starter does not receive any valid serial telegram after the time programmed in P314 has passed, a serial error will occur and the Soft-Starter will take on the action programmed at P313. <input checked="" type="checkbox"/> For more details, see the Soft-Starter SSW-07/SSW-08 Serial Communication Manual. <p>NOTES!</p> <ul style="list-style-type: none"> <input checked="" type="checkbox"/> The Remote/Local keypad exchanges data with the microprocessor through serial communication, therefore this function is also valid for the communication between the keypad and the Soft-Starter. <input checked="" type="checkbox"/> If the serial communication is not being used, this parameter must remain at 0 (Inactive). 										
P331 to P348 Parameters Regarding the DeviceNet Communication	-	<ul style="list-style-type: none"> <input checked="" type="checkbox"/> Parameters for the DeviceNet interface configuration and operation. In order to get a detailed description, refer to the DeviceNet Communication Manual, supplied in electronic format on the CD-ROM that comes with the product. 										

6.5. MOTOR PARAMETERS – P400 to P499

Parameter	Range [Factory Setting] Unit	Description/ Notes
P400 ⁽¹⁾ Motor nominal voltage	1 to 999 [380] 1V	<input checked="" type="checkbox"/> Set according to the data on the motor plate and corresponding to the type of attachment.
P401 ⁽¹⁾ Motor current setting	30.0 to 100.0 [100.0] 0.1%	<input checked="" type="checkbox"/> Sets the value of the motor current in percentage in relation to the nominal current of the Soft-Starter. $P401 = \frac{I_{n_Motor}}{I_{n_SSW}} \times 100\%$ <input checked="" type="checkbox"/> The value of this parameter is directly related to the actuation levels of the motor current protections. <input checked="" type="checkbox"/> With P219=0, the parameter content indicates the value set through the Motor Current trimpot. <input checked="" type="checkbox"/> With P219=1, the parameter content indicates the value set through serial communication or keypad.
P406 ⁽¹⁾ Service factor	1.00 to 1.50 [1.00] -	<input checked="" type="checkbox"/> Set the service factor according to the data on the motor plate.
P501 DC-Braking Time	0 to 299 [0 = Inactive] 1s	<input checked="" type="checkbox"/> P501 sets the time that the braking voltage is applied. <input checked="" type="checkbox"/> This function must be used when reduction of the deceleration time imposed by the load to the system is desired. <input checked="" type="checkbox"/> One contactor is needed to short-circuit the output lines V and W. See the recommended set-up at the User's Manual for more information.  NOTE! Wherever this function is used, you must consider a possible thermal overload on the motor windings. The protection against SSW overload does not operate at DC braking.
P502 DC-Braking Voltage Level	30 to 70 [30] 1%	<input checked="" type="checkbox"/> P502 sets the AC line voltage that is converted directly into DC-voltage and applied on the motor terminals during the braking time.  ATTENTION! <ol style="list-style-type: none"> 1. Be careful with this voltage level. Set it according to the application so that the Soft-Starter and the motor can withstand the settings. 2. Start with low voltage levels and increase them according to the need. 3. The current protections do not work with a DC current because the current transformers saturate with DC current. 4. The Soft-Starter does not protect the motor while it is performing the braking, if no motor PTC sensor is used. 5. To measure this current during braking you need a special current meter with hall effect transformers.

Parameter	Range [Factory Setting] Unit	Description/ Notes						
P510 Jog	0 to 1 [0 = Inactive] -	<input checked="" type="checkbox"/> P510 enables the Jog function. <table border="1" style="margin-left: auto; margin-right: auto;"> <caption>Table 6.14 - Jog Selection</caption> <thead> <tr> <th>P510</th> <th>Description</th> </tr> </thead> <tbody> <tr> <td>0</td> <td>Inactive</td> </tr> <tr> <td>1</td> <td>Active</td> </tr> </tbody> </table>	P510	Description	0	Inactive	1	Active
P510	Description							
0	Inactive							
1	Active							
P511 Jog Level	30 to 70 [30] 1%	<input checked="" type="checkbox"/> P511 sets the voltage level applied to the motor during the Jog function. <div style="display: flex; align-items: center;"> <p>ATTENTION!</p> </div> <ol style="list-style-type: none"> The motor can be enabled during a short period of time only, with Jog. Connect a push-button to a digital input to enable the Jog. The P102 parameter is the time limit protection of the Jog. If this time is exceeded, fault E62 will appear. 						

6.6. PARAMETERS OF THE SPECIAL FUNCTIONS – P500 to P599

P520 ⁽¹⁾⁽³⁾ Voltage pulse at the start (Kick Start)	0 or 1 [0=Inactive] -	<input checked="" type="checkbox"/> The Soft-Starter allows for the use of a voltage pulse in the start for loads that present a great initial resistance to the movement. <input checked="" type="checkbox"/> Enabled through P520=1 and with the duration time adjustable at P521. <input checked="" type="checkbox"/> The voltage level applied during the voltage pulse is defined at P522.
P521 ⁽³⁾ Pulse time at the start	0.2 to 2.0 [0.2] 0.1s	<input checked="" type="checkbox"/> The voltage pulse works equally for voltage ramp control and for current limitation.
P522 Voltage pulse level at the start (%Un)	70 to 90 [80] 1%	<div style="display: flex; align-items: center;"> <p>NOTE!</p> </div> Only use this function for specific applications where necessary.

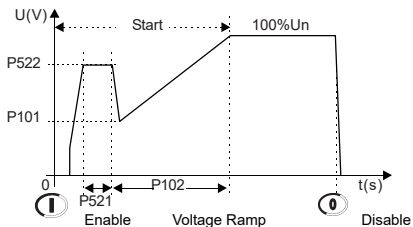


Figure 6.7 - Voltage pulse at the start

6.7. PROTECTION PARAMETERS – P600 to P699

Parameter	Range [Factory Setting] Unit	Description/ Notes
P610⁽¹⁾ Phase Loss or Immediate Undercurrent (% In of the Motor)	1 to 80 [80] 1%In of the motor	<input checked="" type="checkbox"/> The immediate undercurrent parameter P610 defines the percentage of the motor current below the motor nominal current that causes a trip. $P610 = \frac{InMot - Imin}{InMot} * 100\%$
P611⁽¹⁾⁽³⁾ Immediate undercurrent time or phase loss	0=Inactive 1 to 99 [1] 1s	<input checked="" type="checkbox"/> The immediate undercurrent protection trips when the motor current remains below motor nominal current by the percentage set in P610 for the time period set in P611. When it trips, the soft starter disables the motor and indicates phase loss or undercurrent error. The undercurrent protection is especially useful in pump applications, which cannot operate without load.
P612⁽¹⁾ Immediate overcurrent	1 to 200 [100] 1%In of the motor	<input checked="" type="checkbox"/> NOTE! Even before starting the motor the phase loss is already detected by means of the synchronism pulses, i.e., this error is detected through the voltage applied to the power terminals. <input checked="" type="checkbox"/> The immediate overcurrent parameter P612 defines the percentage of the motor current above the motor nominal current that causes the trip. $P612 = \frac{Imax - InMot}{InMot} * 100\%$
P613⁽¹⁾⁽³⁾ Immediate overcurrent time	0=Inactive 1 to 99 [1] 1s	<input checked="" type="checkbox"/> The immediate overcurrent protection trips when the motor current remains above motor nominal current by the percentage set in P612 for the time period set in P613. When it trips, the soft starter disables the motor and indicates overcurrent error. <input checked="" type="checkbox"/> NOTE! The immediate overcurrent protection is active only with full voltage, after the motor has started.

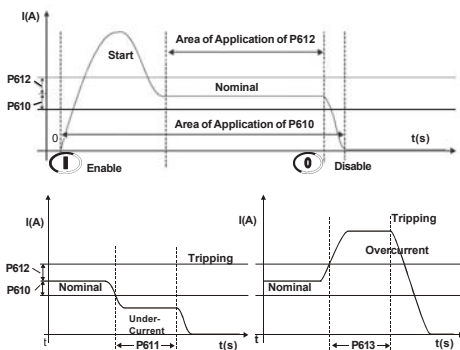






Figure 6.8 - Actuation levels for over and undercurrent

NOTE!

In order to achieve correct operation of the under- and overcurrent protection, adjust the motor nominal current, either via trimpot or via P401.

Parameter	Range [Factory Setting] Unit	Description/ Notes
P614 ⁽¹⁾ Current imbalance between phases (%In of the Motor)	0 to 30 [15] 1%In of the Motor	<ul style="list-style-type: none"> <input checked="" type="checkbox"/> The current imbalance values are set as a percentage of the nominal motor current. <input checked="" type="checkbox"/> P614 sets the maximum value of the current difference among the three motor phases, which can operate without problems during the time set at P615. After this time the Soft-Stater turns off, indicating a current imbalance error.
P615 ⁽¹⁾ Current imbalance time between phases	0=Inactive 1 to 99 [0] 1s	<p> NOTE! These functions only work in full voltage, after the motor start.</p>
P616 ⁽¹⁾ Undercurrent before By-pass closing	0 or 1 [0=Inactive] -	<ul style="list-style-type: none"> <input checked="" type="checkbox"/> When enabled, this function permits undercurrent protection before the By-pass closing. In other words, it prevents the By-pass from closing during a fault in the power supply network or in some thyristor. <input checked="" type="checkbox"/> When disabled, it allows motors to start with a nominal current lower than 10% of the Soft-Starter nominal current.
P617 ⁽¹⁾⁽³⁾ Blocked Rotor	0 or 1 [1=Active] -	<ul style="list-style-type: none"> <input checked="" type="checkbox"/> When enabled, this function permits protection against a blocked rotor at the end of the start. In other words, it keeps the By-pass from closing with an overcurrent greater or equal to 2 times the nominal motor current. <p> NOTE! Only disable this function in cases where the motor withstands superior current duties.</p>
P620 ⁽¹⁾⁽³⁾ RST Phase sequence	0 or 1 [1=Active] -	<ul style="list-style-type: none"> <input checked="" type="checkbox"/> Its function is to protect loads that can only rotate in a single direction. When enabled, it only allows the phase sequence R/1L1, S/3L2, T/5L3. <input checked="" type="checkbox"/> When enabled, the phase sequence is detected every time the motor is turned on. <input checked="" type="checkbox"/> Frequently used in applications with hydraulic pumps that cannot rotate in the opposite direction.
P621 E77 Enabling	0 to 1 [1 = Active] -	<ul style="list-style-type: none"> <input checked="" type="checkbox"/> The bypass contactor closed protection (E77), acts improperly when the motor is disconnected from the Soft-Starter before the Stop command. This improper performance of the E77 is common in multimotor applications. <p> NOTE! Only disable this protection to make possible the use of the SSW-07/SSW-08 in multimotor applications, that is, when a SSW-07/SSW-08 starts more than a motor.</p>
P622 ⁽¹⁾ SSW Short Circuit	0 to 1 [0=Inactive]	<ul style="list-style-type: none"> <input checked="" type="checkbox"/> Its function is to protect the motor when a short circuit occurs in the power circuit of the Soft-Starter, thyristors or by-pass with the motor stopped, that is, without the Run command. <p> NOTE! This protection will only be actuated through contactor or circuit breaker of the power isolation, and it is deactivated by the error output.</p>

Parameter	Range [Factory Setting] Unit	Description/ Notes
P630 Time interval after stopping	2 to 999 [2] 1s	<input checked="" type="checkbox"/> This protection limits the minimum time interval between the starts after the end of the deceleration ramp.

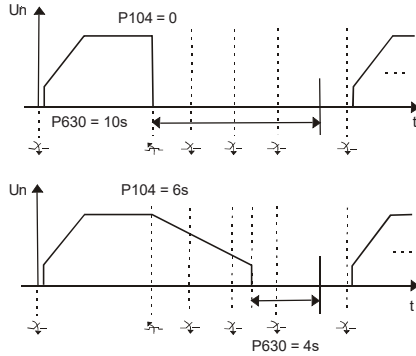


Figure 6.9 - Activation via three wire, digital inputs (DI1 and DI2)

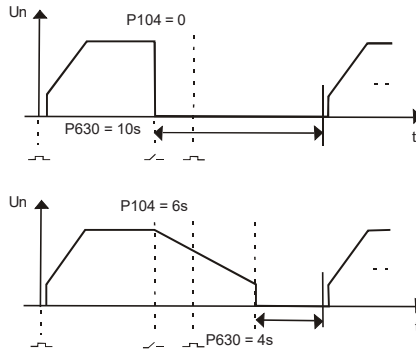


Figure 6.10 - Activation via two wire, digital inputs (DI1)

OBSERVATION:

The activate command will only be dealt with after the time interval programmed at P630 has passed.

NOTES!

- 1) The time interval initiates its count at the end of the deceleration ramp.
- 2) If the control card supply is removed, there will be no time count.

Parameter	Range [Factory Setting] Unit
P640 ⁽¹⁾⁽³⁾	0=Inactive
Motor protection thermal class	1 to 6 [6] -

Description/ Notes

Table 6.15 - Thermal classes

P640	Thermal Class
0	Inactive
1	Class 5
2	Class 10
3	Class 15
4	Class 20
5	Class 25
6	Class 30

- ☑ Soft-Starter SSW-07/SSW-08 has a rigid, effective and totally programmable Thermal Protection to protect your motor. All Soft-Starter SSW-07/SSW-08 models have this protection, which upon actuation, indicates an overload error and turns the motor off.
- ☑ This Thermal Protection has curves that simulate the motor heating and cooling. All calculations are done through a complex software that estimates the motor temperature through the True RMS current supplied.
- ☑ The actuation curves of the motor Thermal Protection are based on IEC 60947-4-2 standards.
- ☑ The heating and cooling curves of the motor are based on many years of WEG motor development. They adopt the IP55 Three Phase Motor as a standard and also consider if the motor is cooling while activated or not.
- ☑ The cooling time of the thermal image depends on the motor power. In other words, for each power there is a different cooling time. Where there is a need to decrease this time, the P641 can be used.
- ☑ The estimated value of the motor temperature is saved in non-volatile memory every time the control card supply is removed. Therefore, after supplying the control card, the last saved value will be returned.
- ☑ The thermal image can be reset, disabling and enabling the motor overload protection.

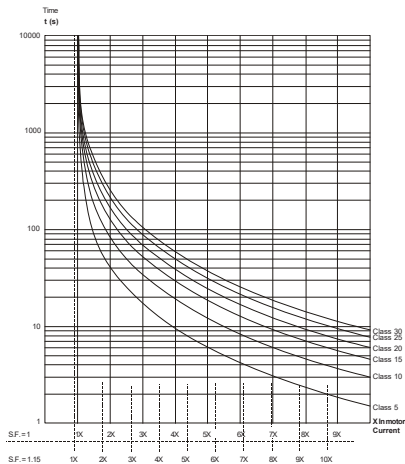


Figure 6.11 - Thermal class protection for cold motor

Parameter	Range [Factory Setting] Unit	Description/ Notes
-----------	------------------------------------	--------------------

Table 6.16 - Thermal class protection times for cold motor with S.F.=1

Motor Current	Class		
	30	20	10
3xIn	101.2s	67.5s	33.7s
5xIn	36.1s	24s	12s
7xIn	18.3s	12.2s	6.1s

Table 6.17 - Thermal class protection times for cold motor with S.F.=1.15

Motor Current	Class		
	30	20	10
3xIn	135.1s	90.1s	45.1s
5xIn	47.7s	31.8s	15.9s
7xIn	24.3s	16.2s	8.1s

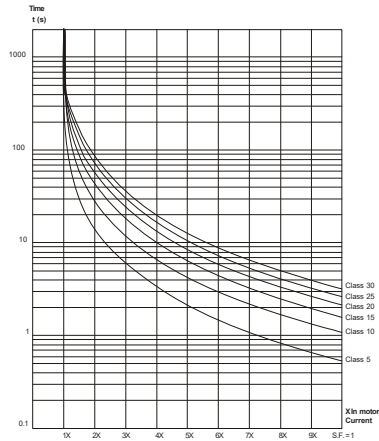



Figure 6.12 - Thermal class protection for hot motor with 100%In

Table 6.18 - Thermal class protection times for hot motor

Motor Current	Class		
	30	20	10
3xIn	34.4s	23.6s	11.8s
5xIn	12.6s	8.4s	4.2s
7xIn	6.4s	4.2s	2.1s

Table 6.19 - Multiplication factor of the thermal class protection times for cold motor to obtain the thermal class times for hot motor

Current as a %In of the Motor	Factor
0%(cold)	1
20%	0,87
40%	0,74
60%	0,61
80%	0,48
100% (rated load)	0,35

Parameter	Range [Factory Setting] Unit	Description/ Notes
		<p> NOTE!</p> <p>If there are various thermal classes it is because it is necessary to program exactly one that best adapts to its application and protects the motor inside its permitted work duty.</p> <p>When using a motor with a PTC thermal sensor or thermostat connected internally to the Soft-Starter, there is no need to enable the thermal classes, therefore, disable the motor overload protection. To connect a PTC thermal sensor to the Soft-Starter SSW-07/SSW-08, it is necessary to use an optional module. See the chapter Options and Accessories in the SSW-07/SSW-08 User's Guide.</p>

P641 ⁽¹⁾ Thermal memory auto-reset	0 to 600 [0=Inactive] 1s	<ul style="list-style-type: none"> <input checked="" type="checkbox"/> Sets the time for the auto-reset of the motor thermal image. <input checked="" type="checkbox"/> This function can be used in applications that need various starts per hour or shorter time intervals between the motor start and stop. <input checked="" type="checkbox"/> The thermal image cooling time depends on the power of the motor. In other words, for each power there is a different cooling time. <input checked="" type="checkbox"/> The thermal image can also be reset by disabling and enabling the motor overload protection.
--	----------------------------------	--

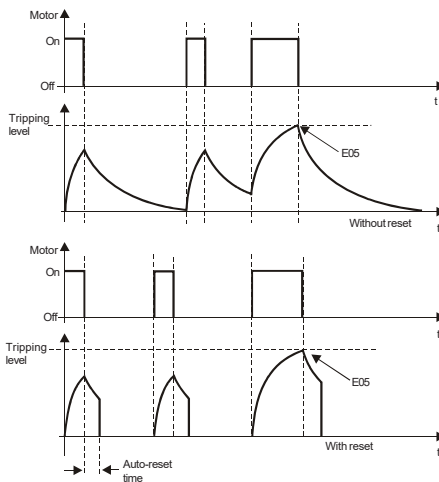




Figure 6.13 - Thermal memory auto-reset

 **NOTE!**
 Remember that using this function can decrease the lifetime of the motor winding used.

7. ERRORS AND POSSIBLE CAUSES

When an error is detected, the motor is deactivated and the error is displayed.

To return the Soft-Starter to normal operation after the occurrence of an error, it is necessary to reset it. This can generally be done in the following ways:

- By turning off the power supply and turning it back on (Power-on reset);
- Through the reset button in the front panel of the Soft-Starter SSW-07/SSW-08 (Reset button);
- Automatically, through the automatic reset (auto-reset);
- Via digital inputs (DIx);
- By pressing the  key of the keypad (manual reset);
- By serial communication (Serial).

Description of the Protection and Fault Display	Activation Description	Probable Causes	Related Parameters	Reset
<p>Phase loss or undercurrent</p> <p>E03</p> <p>(LED Phase Loss)</p> <p>Flashing</p>	<p>- At starting: It occurs when there is no voltage in the power supply terminals (R/1L1, S/3L2 and T/5L3) or when the motor is disconnected.</p> <p>- With the motor running: It trips when the current stays below the programmed value longer than the programmed time. Referring the motor nominal current. When the parameters are set with the factory default values, then this protection trips after elapsing 1 second with phase loss either at the input or the at the output (motor). It trips when the current circulating through the SSW-07/SSW-08 is less than 20% of the value adjusted at the Motor Current trimpot.</p>	<p>- Percentage values programmed as the maximum acceptable limit of the undercurrent (P610) is below the necessary value for the motor and the application.</p> <p>- In hydraulic pump application, it may be running without load.</p> <p>- Phase loss in the three-phase network.</p> <p>- Short-circuit or thyristor or By-pass fault.</p> <p>- Motor not connected.</p> <p>- Motor connection is incorrect.</p> <p>- Loose contact in the connections.</p> <p>- Starting problems with the input contactor.</p> <p>- Input fuses are blown.</p> <p>- Undersized input transformers.</p> <p>- Incorrect programming of the Motor Current trimpot.</p> <p>- Motor with a current consumption lower than required for phase loss protection to work.</p>	<p>P610 P611 P401</p>	<p>Power-on. Manual reset. Reset key. Auto-reset. DIx. Serial.</p>
<p>Overtemperature in the power section</p> <p>E04</p> <p>(LED Fault) Flashes once</p> <p>(LED Ready) On</p>	<p>- When the heatsink temperature is higher than the limit value.</p> <p>- Also works when the temperature sensor is not connected.</p> <p>When the time limits given by the time x temperature curves of SCR protection are exceeded.</p>	<p>- Load on the shaft too great.</p> <p>- Elevated number of successive starts.</p> <p>- Internal temperature sensor not connected.</p> <p>- Starting cycle requires ventilation kit (models from 45 A to 200 A).</p>	-	<p>Power-on. Manual reset. Reset key. Auto-reset. DIx. Serial.</p>
<p>Electronic motor overload</p> <p>E05</p> <p>(LED Overload) Flashing</p>	<p>- When the times given by the programmed thermal class curves are exceeded.</p>	<p>- "Motor Current" trimpot incorrectly set (setting of the motor current). The set value too low for the motor being used.</p> <p>- Starting sequence greater than that allowed.</p> <p>- Programmed thermal class below the duty permitted by the motor.</p> <p>- Time between stopping and starting below what is permitted by the cooling time for that motor power.</p> <p>- Load on the shaft too high.</p> <p>- Thermal protection saved when the control is turned off and brought back when turned back on.</p>	<p>P640 P641 P401 P406</p>	<p>Power-on. Manual reset. Reset key. Auto-reset. DIx. Serial.</p>

Description of the Protection and Fault Display	Activation Description	Probable Causes	Related Parameters	Reset
External fault (DI) E06 (LED Fault) Flashes 3 times (LED Ready) On	-When there is the opening for the digital input programmed for external fault.	- Open digital input wiring programmed for external fault.	P263 P264 P265	Power-on. Manual reset. Reset key. Auto-reset. Dlx. Serial.
Fault in the Copy function E10	- When the keypad is loaded with parameters of a different version than the Soft-Starter.	- Attempt to copy the keypad parameters to Soft-Starters with incompatible software versions.	P215	Power-on. Manual reset. Reset key. Dlx. Serial.
Short circuit in the SSW power E19 (Fault LED) Flashes 7 times (Ready LED) is off	- When the current value in one of the phases is above 30% of the Soft-Starter rated current with the motor stopped, that is, without the Run command.	- Short circuit in some thyristor or relay of internal by-pass. - External short circuit in parallel with the Soft-Starter power. - Defect in the current analog reading.	P622	Power-on. Manual reset. Reset key. Dlx. Serial.
Programming fault E24	- When there is an attempt to set a parameter that is incompatible with the others.	- Attempt to set a parameter that is incompatible with the others. See table 5.1.	-	Automatic reset after fault correction.
Timeout fault in telegram reception E28 (Communication module LED Error) Flashes once	- When the Soft-Starter stops receiving telegrams from the master for a period longer than the one programmed in P314.	- The timeout time programmed in P314 is shorter than the time between the telegrams sent by the network master. - The network master does not send telegrams cyclically, program P314=0. - If the serial communication is not being used, program P314=0. - For further details, see the Serial Communication Manual of Soft-Starter SSW-07/SSW-08.	P313 P314	Automatic reset after fault correction.
Keypad connection fault E31	- When the physical connection between the keypad and the Soft-Starter is interrupted.	- Bad-contact in the keypad cable. - Electric noise in the installation (electromagnetic interference).	-	Automatic reset after fault correction.
Excess current limit start timeout E62 (LED Fault) Flashes twice (LED Ready) On	- When the starting time is longer than the time set in the acceleration ramp tripot. Active only with a current limit starting.	- Time programmed for the acceleration ramp shorter than what is necessary. - Programmed current limitation value too low. - Locked motor, blocked rotor.	P102 P110 P202	Power-on. Manual reset. Reset key. Auto-reset. Dlx. Serial.
Stall E63 (LED Stall) Flashing	- Activates before full voltage, if the current is greater than twice the nominal motor current.	- Programmed acceleration ramp time lower than the actual acceleration time. - Locked motor shaft (blocked). - The transformer that supplies the motor can be saturating and taking too much time to recover from the starting current.	P617 P401	Power-on. Manual reset. Reset key. Auto-reset. Dlx. Serial.

Description of the Protection and Fault Display	Activation Description	Probable Causes	Related Parameters	Reset
<p>Overcurrent</p> <p>E66</p> <p>(LED Overcurrent) Flashing</p>	<p>- When the current value is above the value programmed during the time programmed. In reference to the nominal motor current.</p> <p>- It is only monitored when the SSW-07/SSW-08 is in full voltage (100% of the voltage).</p> <p>- With parameters programmed at factory default values, this protection turns on when the motor current passes the value in 3 times the nominal motor current, for more than 1s.</p>	<p>- Short-circuit between the phases.</p> <p>- Momentary motor overload.</p> <p>- Locked motor shaft, blocked rotor.</p>	<p>P612 P613 P401</p>	<p>Power-on. Manual reset. Reset key. Auto-reset. Dlx. Serial.</p>
<p>Incorrect phase sequence</p> <p>E67</p> <p>(LED Phase Seq) Flashing</p>	<p>- When the sequence of synchronism signal interruptions does not follow the RST sequence.</p>	<p>- Inverted input network phase sequence.</p> <p>- May have been changed in another place of the supply network.</p> <p>- Motor connection is incorrect.</p>	<p>P620</p>	<p>Power-on. Manual reset. Reset key. Dlx. Serial.</p>
<p>Undervoltage in the control supply</p> <p>E70</p> <p>(LED Fault) Flashes twice</p> <p>(LED Ready) Off</p>	<p>- Activates on when the control supply voltage is lower than 93Vac.</p>	<p>- Electronic supply lower than the minimum value.</p> <p>- Electronics power supply with loose contact.</p> <p>- Electronics power supply fuse are blown.</p>	<p>-</p>	<p>Power-on. Manual reset. Reset key. Auto-reset. Dlx. Serial.</p>
<p>Internal By-pass relay contact open</p> <p>E71</p> <p>(LED Fault) Flashes 3 times</p> <p>(LED Ready) Off</p>	<p>- When there is a fault with the internal By-pass relay contacts at full voltage.</p>	<p>- Loose contact in the starting cables of the internal By-pass relays.</p> <p>- Defective By-pass relay contacts due to an overload.</p> <p>- Incorrect electronic supply voltage, only for SSW-07/SSW-08 models 255-412A.</p>	<p>-</p>	<p>Power-on. Manual reset. Reset key. Auto-reset. Dlx. Serial.</p>
<p>Overcurrent before the By-pass</p> <p>E72</p> <p>(LED Fault) Flashes 4 times</p> <p>(LED Ready) Off</p>	<p>- Activates before the closing of the By-pass if the current is greater than: 37.5A for the SSW models up to 30A; 200A for the SSW models of 45 to 85 A; 260A for the SSW models of 130A; 400A for the SSW models of 171 to 200A.</p>	<p>- Programmed acceleration ramp time shorter than the actual acceleration time.</p> <p>- Nominal motor current above the current tolerated by the Soft-Starter.</p> <p>- Locked motor shaft, blocked rotor.</p>	<p>-</p>	<p>Power-on. Manual reset. Reset key. Auto-reset. Dlx. Serial.</p>
<p>Current imbalance</p> <p>E74</p> <p>(LED Fault) Flashes 5 times</p> <p>(LED Ready) On</p>	<p>- When the current value of one of the phases is above or below the value programmed, during the time programmed. In reference to the other motor phases.</p>	<p>- Value programmed at P614 and P615 is beyond the limits tolerated for its application.</p> <p>- Voltage loss in one or more phase of the supply network.</p> <p>- Phase loss in the supply network.</p> <p>- Under-dimensioned input transformers.</p> <p>- Open input fuses.</p> <p>- Bad contact in the motor connections or in the supply network.</p>	<p>P614 P615</p>	<p>Power-on. Manual reset. Reset key. Auto-reset. Dlx. Serial.</p>

Description of the Protection and Fault Display	Activation Description	Probable Causes	Related Parameters	Reset
Supply network frequency out of tolerated range E75 (LED Fault) Flashes once (LED Ready) Off	- When the frequency is higher or lower than the limits of 45Hz to 66Hz.	- The line frequency is out of range. - When the Soft-Starter + the motor are being supplied by a generator that is not supporting the full load regime or the start of the motor.	-	Power-on. Manual reset. Reset key. Auto-reset. Dlx. Serial.
Undercurrent before the By-pass closing E76 (LED Fault) Flashes 4 times (LED Ready) On	- When at the end of the acceleration ramp and before the internal By-pass relay closing, the current is lower than 0.1x the Soft-Starter nominal current (P295x0.1).	- Supply network voltage fault or fault in the thyristor before the By-pass closing. - Incorrect Soft-Starter nominal current programmed at P295. - Nominal motor current below the minimum current. - P616=0 can be set for tests.	P616	Power-on. Manual reset. Reset key. Auto-reset. Dlx. Serial.
Closed by-pass contact or shorted SCR's E77 (Fault LED) flashes 6 times (Ready LED) is off	- When there is no opening of the internal by-pass contact circuit.	- Bad contact in the relay activation cables, at either internal or external by-pass. - Defective contacts due to an overload. - A short-circuit in parallel or external.	P621	Power-on. Manual reset. Reset key. Dlx.

OBSERVATIONS:

When **E04** message is displayed (Soft-Starter overtemperature), wait a few minutes for it to cool down before it can be reset.

When **E05** message is displayed (motor overload) wait a few minutes for it to cool down the motor slightly before the Soft-Starter can be reset.

NOTES!

Fault Actuation Forms:

E24

- Indicates the error code on the keypad display.
- Motor can not be started.
- Switches off the relay that has been programmed to "No Fault".
- Switches on the relay that has been programmed to "Fault".

E28:

- Indicates the code in the LED display.
- The actuation form can be configured at P313.

E31:

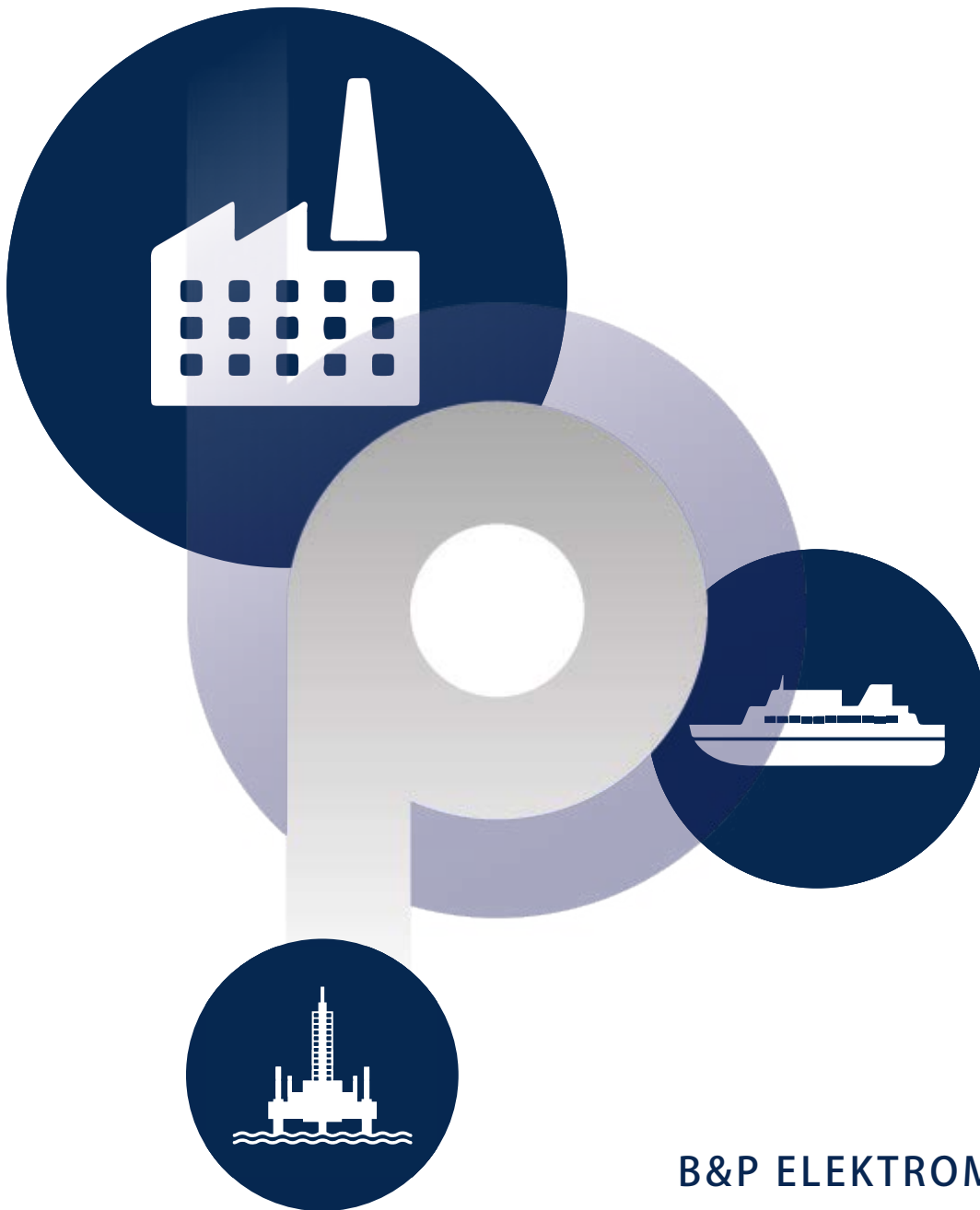
- The Soft-Starter proceeds operation normally, depending on how it is programmed at P313 and P314.
- No Keypad commands are accepted.
- Indicates the code on the keypad display.

E70:

- It will not be saved in the last six faults memory when the power supply is switched off (line disconnection) with stopped motor.

OTHER FAULTS:

- Relay is switched off when programmed to "No Fault".
- Relay is switched on when programmed to "Fault".
- Motor is switched off, when it is enabled.
- Indicates the fault code in the keypad display and/or on the front cover of SSW-07/SSW-08.



B&P ELEKTROMOTOREN BV

Expeditiweg 21
6657 KM Boven-Leeuwen

info@bnpelektromotoren.nl

+31 (0)344 616 267

BTW nr. NL819113918B01

KvK nr. 30237800

ING Bank NL60 INGB 0675 304 792



www.bnpelektromotoren.nl