



B&P Elektromotoren

ENGINEERING
TOMORROW



Application Guide

VACON® NXP DCGuard™



Contents

1	Introduction	6
1.1	Purpose of this Application Guide	6
1.2	Manual and Software Version	6
1.3	Additional Resources	6
1.4	Parameter Table Reading Guide	6
1.5	Application Functionality	7
1.6	Application Requirements	7
1.7	System Integrator Responsibilities	7
2	Control I/O	8
2.1	Control I/O Configuration	8
3	Monitoring Values	9
3.1	Monitoring 1	9
3.2	Monitoring 2	9
3.3	Fieldbus	9
4	Parameter Lists	11
4.1	Basic Parameters	11
4.2	Input Signals	11
4.2.1	Basic Settings	11
4.2.2	Digital Inputs	11
4.2.3	Analog Input 1	12
4.2.4	Analog Input 2	12
4.2.5	Analog Input 3	13
4.2.6	Analog Input 4	13
4.2.7	Options	13
4.3	Output Signals	13
4.3.1	Digital Outputs	13
4.3.2	Analog Output 1	14
4.3.3	Analog Output 2	14
4.3.4	Analog Output 3	15
4.3.5	Supervision Limit	15
4.4	Limit Settings	15
4.4.1	Current Limit	15
4.5	Drive Control Parameters	16
4.5.1	Identification	16
4.6	Master/Follower	16

4.7	Fieldbus Parameters	16
4.8	Protections	17
4.8.1	General	18
4.8.2	U Phase Over Load Protection	18
4.8.3	V Phase Over Load Protection	18
4.8.4	W Phase Over Load Protection	19
4.8.5	U Phase Current Protection	19
4.8.6	V Phase Current Protection	19
4.8.7	W Phase Current Protection	19
4.9	ID Functions	20
4.9.1	Value Control	20
4.9.2	DIN ID Control 1	21
4.9.3	DIN ID Control 2	21
4.9.4	DIN ID Control 3	21
4.10	Keypad Control	21
4.11	System Menu (Control Panel: Menu M6)	21
4.12	Expander Boards (Control Panel: Menu M7)	22
5	Monitoring Value Descriptions	23
5.1	Monitoring 1 Values	23
5.2	Monitoring 2 Values	24
5.3	Fieldbus Monitoring Values	29
6	Parameter Descriptions	31
6.1	Basic Parameters	31
6.2	Input Signals	32
6.2.1	Basic Settings	32
6.2.2	Digital Inputs	32
6.2.3	Analog Inputs	34
6.2.3.3	Analog Input 1	34
6.2.3.4	Analog Input 2	36
6.2.3.5	Analog Input 3	37
6.2.3.6	Analog Input 4	38
6.2.4	Options	39
6.3	Output Signals	39
6.3.1	Digital Outputs	39
6.3.2	Analog Outputs	41
6.3.2.1	Parameter Set-up Examples	41
6.3.2.2	Analog Output 1	41

6.3.2.3	Analog Output 2	43
6.3.2.4	Analog Output 3	44
6.3.3	Supervision Limit	45
6.4	Limit Settings	45
6.4.1	Current Limit	45
6.5	Drive Control Parameters	46
6.5.9	Identification	47
6.6	Master/Follower	48
6.7	Fieldbus Parameters	48
6.8	Protections	50
6.8.4	General	51
6.8.5	Over Load Protection	51
6.8.5.1	Function Description	51
6.8.5.2	U Phase Over Load Protection	52
6.8.5.3	V Phase Over Load Protection	53
6.8.5.4	W Phase Over Load Protection	53
6.8.6	U Phase Current Protection	54
6.8.7	V Phase Current Protection	54
6.8.8	W Phase Current Protection	55
6.9	ID Functions	55
6.9.2	Value Control	55
6.9.4	DIN ID Control 1	59
6.9.5	DIN ID Control 2	59
6.9.6	DIN ID Control 3	60
6.10	Keypad Control	60
6.11	"Terminal to Function" (TTF) Programming Principle	61
6.11.1	Defining an Input/Output for a Certain Function on Keypad	61
6.11.2	Defining a Terminal for a Certain Function with VACON® NCDrive	62
6.11.3	Defining Unused Inputs/Outputs	63
6.12	Fieldbus Control In Detail	63
6.12.1	Fieldbus Control Word (Standard)	63
6.12.2	Fieldbus Control Word (DCGuard Profile 1)	64
6.12.3	Fieldbus Status Word	65
6.12.4	Application Status Word	66
7	Fault Tracing	68
7.1	Troubleshooting Guidelines	68
7.2	Faults and Alarms	68

1 Introduction

1.1 Purpose of this Application Guide

This Application Guide provides information for configuring the system, controlling the AC drive, accessing parameters, programming, and troubleshooting of the AC drive. It is intended for use by qualified personnel. To use the drive safely and professionally, read and follow the instructions. Pay particular attention to the safety instructions and general warnings that are provided in this manual and other documentation delivered with the drive.

The VACON® NXP DCGuard™ application software and this application manual are made according to the same guidelines as other VACON® NXP applications, where the NXP inverter is used to control a motor. The functionality of the DCGuard is fundamentally different from motor control, although the hardware and system software is the same.

1.2 Manual and Software Version

This manual is regularly reviewed and updated. All suggestions for improvement are welcome. The original language of this manual is English.

Table 1: Manual and Software Version

Version	Release date	Remarks	Software version
B	05.08.2020	Updated Input Signals and Drive Control parameters. Added ID Functions parameters.	ADFIF102V046

1.3 Additional Resources

Other resources are available to understand advanced AC drive functions, installation, operation, and options.

- The VACON® NXP DCGuard™ design guide provides technical information to understand the capabilities of the VACON® NXP DCGuard™ application.
- The VACON® NXP DCGuard™ operating guide provides information about the installation and operation of the VACON® NXP DCGuard™ application.
- VACON® NXP Common DC Bus and VACON® NXP Liquid-cooled Common DC Bus user manuals provide detailed information for the installation, commissioning, and operation of the AC drive modules.
- The operating and installation guides for VACON® options give detailed information about specific drive options.

Supplementary publications and manuals are available from Danfoss . See www.danfoss.com for listings.

1.4 Parameter Table Reading Guide

This manual includes a large quantity of parameter tables. These instructions tell you how to read the tables.

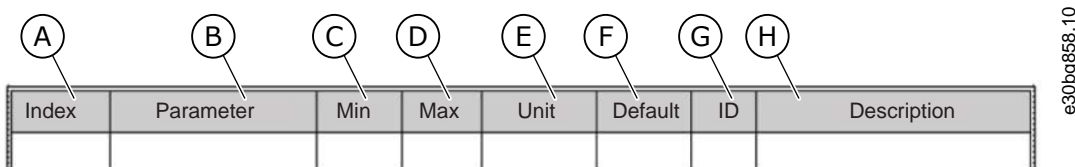

Illustration 1: Parameter Table Reading Guide

<p>A The location of the parameter in the menu, that is, the parameter number.</p> <p>B The name of the parameter.</p> <p>C The minimum value of the parameter.</p> <p>D The maximum value of the parameter.</p>	<p>E The unit of the value of the parameter. The unit shows if it is available.</p> <p>F The value that was set in the factory.</p> <p>G The ID number of the parameter.</p> <p>H A short description of the values of the parameter and/or its function.</p>
--	---

1.5 Application Functionality

VACON® NXP DCGuard™ is a fast DC current cutter device that detects and cuts off an outgoing short-circuit current. The main function is to isolate the faulty DC grid from the healthy DC grid, before that fault affects the healthy DC grid.

Two inverter units in a DCGuard peer-to-peer topology are required to be able to cut off short-circuit current both ways.

VACON® NXP DCGuard™ consist of VACON® NXP inverter units and application software ADFIF102. To ensure the correct functionality and safety level, always use the following components together with the DCGuard in a peer-to-peer system:

- An upstream mechanical disconnecter if safe disconnection is required.
- Type aR supply fuses in each DC supply line (see the VACON® NXP DCGuard™ design guide for instructions).
- A dU/dt filter (a standard VACON® dU/dt filter can be used).

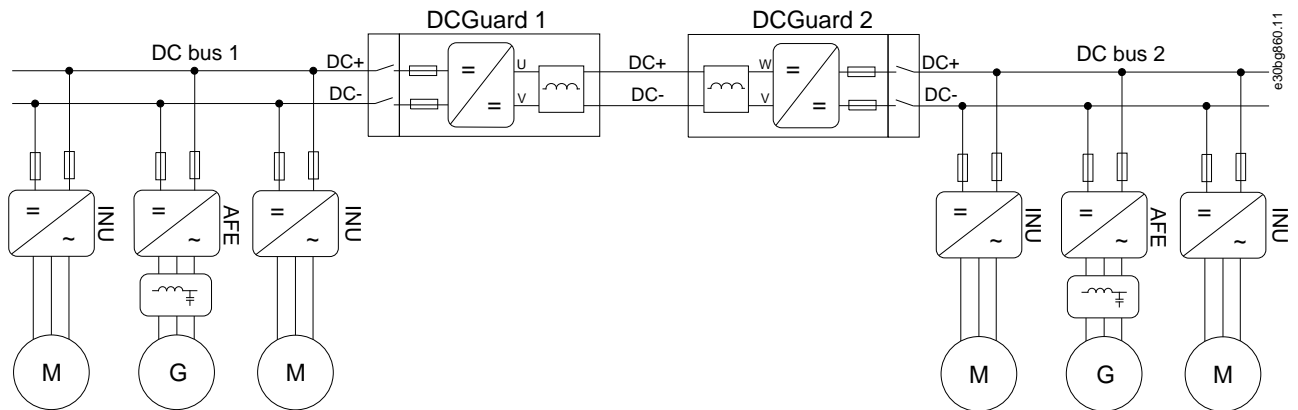

Illustration 2: VACON® NXP DCGuard™ Peer-to-Peer Topology

1.6 Application Requirements

The VACON® NXP DCGuard™ application requires:

- NXP3 control board VB761 revision D or newer.
- System software version NXP00002V193 or newer.

1.7 System Integrator Responsibilities

The VACON® NXP DCGuard™ is developed to be used as a component in a common-DC system. System design and control must be done by the system integrator.

The VACON® NXP DCGuard™ peer-to-peer system is made of two independent DCGuard units, although they operate as a pair. It is the responsibility of the system integrator to implement the two DCGuard units in to the system, to ensure correct functionality, and to ensure correct safety level.

Especially consider the following when designing the system:

- A fault in one of the two DCGuard units must lead to the opening of the other DCGuard unit.
- To ensure safe disconnection of the VACON® NXP DCGuard™ and the bus-tie cables, a mechanical disconnecter is required in front of each DCGuard.
- The mechanical disconnecter in front of each DCGuard unit must only be closed when the voltage level on both sides of the mechanical disconnecter is within the limits of the mechanical disconnecters closing capacity. Meaning that the inrush current is within the mechanical disconnecters closing capacity.
- The mechanical disconnecter in front of each DCGuard unit must only be opened when the conducted current is less than the maximum breaking capability of the mechanical disconnecter.
- Closing a DCGuard unit must only be possible when the other side of the system is ready to be powered up.
- VACON® NXP liquid-cooled inverters do not control or monitor the cooling liquid flow through their own cooling elements. The system integrator must therefore take responsibility of implementing sufficient control and monitoring of the cooling liquid circuit.
- If the active control place for the DCGuard unit is keypad, make sure that there is a possibility to stop the DCGuard also in case the keypad is removed from the drive. In case the parameter *Keypad/PC fault mode* (ID 1329) is set to 0/No response or 1/Warning, it must be ensured on system level that there is the possibility for local control. This can be done, for example, by forcing to I/O or fieldbus control by a digital input.

2 Control I/O

2.1 Control I/O Configuration

The figure shows the default I/O configuration for the VACON® NXP DCGuard™ application and a basic description of the terminals and signals of the I/O board.

For more information on control terminals, see the VACON® NXP DCGuard™ application guide.

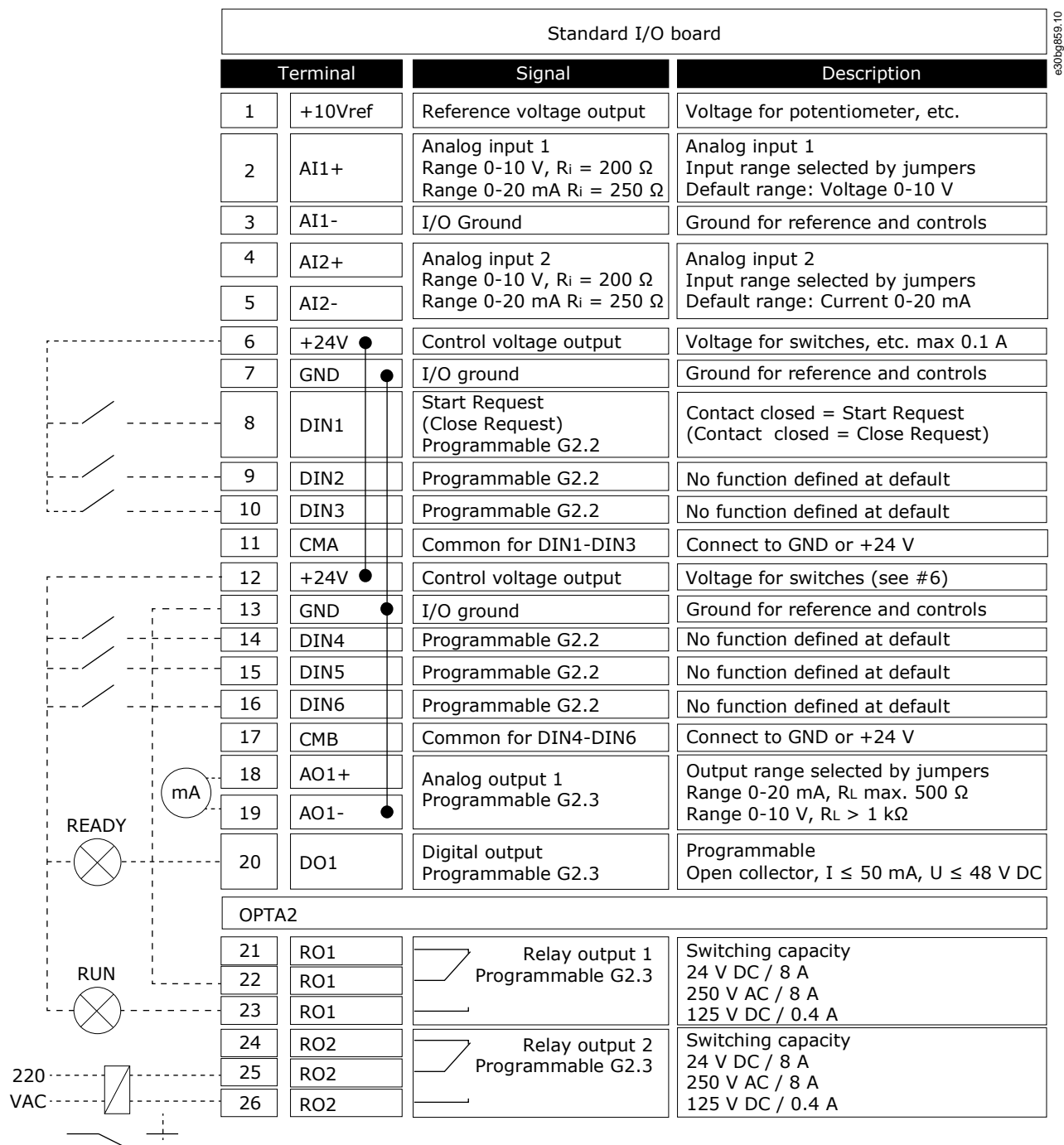

Illustration 3: The Default I/O Configuration for the VACON® NXP DCGuard™ Application

3 Monitoring Values

3.1 Monitoring 1

Table 2: Monitoring 1 Values

Index	Monitoring value	Unit	Form	ID	Description
V1.1.1	DC-Link Amps	A	Varies	3	
V1.1.2	DC-Link Current	%	##	1861	
V1.1.3	DC-Link Voltage	V	#	7	Measured DC-link voltage in Volts, filtered
V1.1.4	Unit Temperature	°C	#	8	Heat sink temperature
V1.1.5	Power kW	kW	Varies	73	
V1.1.6	DC-Link Power	%	##	5	
V1.1.7	Analogue Output 1	%	###	26	
V1.1.8	Analogue Output 2	%	###	31	
V1.1.9	Analogue Output 3	%	###	32	

3.2 Monitoring 2

Table 3: Monitoring 2 Values

Index	Monitoring value	Unit	Form	ID	Description
V1.2.1	DC Voltage	V	#	44	Unfiltered
V1.2.2	U Phase Current	A	Varies	1851	
V1.2.3	V Phase Current	A	Varies	1852	
V1.2.4	W Phase Current	A	Varies	1868	
V1.2.5	U Phase Power	kW	Varies	1871	
V1.2.6	V Phase Power	kW	Varies	1872	
V1.2.7	W Phase Power	kW	Varies	1873	
V1.2.8	Status Word		#	43	
V1.2.9	DIN Status Word 1		#	56	
V1.2.10	DIN Status Word 2		#	57	
V1.2.11	DCGuard Status Word		#	1869	
V1.2.12	DCGuard Control Status		#	1870	
V1.2.13	Data Logger Trigger Word		#	97	

3.3 Fieldbus

Table 4: Fieldbus Values

Index	Monitoring value	Unit	Form	ID	Description
V1.3.1	FB Control Word		#	1160	
V1.3.2	FB Status Word		#	65	

Index	Monitoring value	Unit	Form	ID	Description
V1.3.3	Last Active Fault		#	37	
V1.3.4	Last Active Warning		#	74	
V1.3.5	Fault Word 1		#	1172	
V1.3.6	Warning Word 1		#	1174	

4 Parameter Lists

4.1 Basic Parameters

Table 5: Basic Parameters

Index	Parameter	Min.	Max.	Unit	Default	ID	Description
P2.1.1	Cabling	0	3		0	1503	0 = Not Selected 1 = UDC+, VDC-, WDC+ 2 = U-DC+, V-DC- 3 = V-DC-, W-DC+

4.2 Input Signals

4.2.1 Basic Settings

Table 6: Basic Settings

Index	Parameter	Min.	Max.	Unit	Default	ID	Description
P2.2.1.1	Start/Stop Logic	0	2		0	300	Logic = 0 Ctrl sgn 1 = Start Ctrl sgn 2 = No action Logic = 1 Ctrl sgn 1 = R pulse Ctrl sgn 2 = No action Logic = 2 Ctrl sgn 1 = R pulse Ctrl sgn 2 = R pulse

4.2.2 Digital Inputs

Table 7: Digital Inputs

Index	Parameter	Min.	Max.	Unit	Default	ID	Description
P2.2.2.1	Start Signal 1	0.1	E.10	DigIn	A.1	403	Close command
P2.2.2.2	Start Signal 2	0.1	E.10	DigIn	0.1	404	Close command
P2.2.2.3	Run Enable 1	0.1	E.10	DigIn	0.2	407	Interlock for closing command
P2.2.2.4	Run Enable 2	0.1	E.10	DigIn	0.2	1860	Interlock for closing command
P2.2.2.5	Fault Reset	0.1	E.10	DigIn	0.1	414	
P2.2.2.6	External Fault 1	0.1	E.10	DigIn	0.1	405	
P2.2.2.7	External Fault 2	0.1	E.10	DigIn	0.2	406	
P2.2.2.8	Enable U	0.1	E.10	DigIn	0.2	1515	
P2.2.2.9	Enable V	0.1	E.10	DigIn	0.2	1516	
P2.2.2.10	Enable W	0.1	E.10	DigIn	0.2	1517	
P2.2.2.11	Reset U	0.1	E.10	DigIn	0.2	1518	
P2.2.2.12	Reset V	0.1	E.10	DigIn	0.2	1520	
P2.2.2.13	Reset W	0.1	E.10	DigIn	0.2	1519	

Index	Parameter	Min.	Max.	Unit	Default	ID	Description
P2.2.2.14	Overload U	0.1	E.10	DigIn	0.2	1521	
P2.2.2.15	Overload V	0.1	E.10	DigIn	0.2	1522	
P2.2.2.16	Overload W	0.1	E.10	DigIn	0.2	1523	
P2.2.2.17	I/O Term Control	0.1	E.10	DigIn	0.1	409	Force control place to remote I/O
P2.2.2.18	Keypad Control	0.1	E.10	DigIn	0.1	410	Force control place to local keypad
P2.2.2.19	Fieldbus Control	0.1	E.10	DigIn	0.1	411	Force control place to remote fieldbus

4.2.3 Analog Input 1

Table 8: Analog Input 1

Index	Parameter	Min.	Max.	Unit	Default	ID	Description
P2.2.3.1	A1 Signal Sel	0.1	F.10		0.1	377	
P2.2.3.2	A1 Filter Time	0.000	32.000	s	0.000	324	
P2.2.3.3	A1 Custom Min	-160.00	160.00	%	0.00	321	
P2.2.3.4	A1 Custom Max	-160.00	160.00	%	100.00	322	
P2.2.3.5	A1 Signal Inv	0	1		0	387	0 = No inversion 1 = Inverted
P2.2.3.6	A1 Scale Min	-32000	32000		0	303	
P2.2.3.7	A1 Scale Max	-32000	32000		10000	304	
P2.2.3.8	A1 Controll. ID	0	10000		0	1507	

4.2.4 Analog Input 2

Table 9: Analog Input 2

Index	Parameter	Min.	Max.	Unit	Default	ID	Description
P2.2.4.1	A2 Signal Sel	0.1	F.10		0.1	388	
P2.2.4.2	A2 Filter Time	0.000	32.000	s	0.000	329	
P2.2.4.3	A2 Custom Min	-160.00	160.00	%	0.00	326	
P2.2.4.4	A2 Custom Max	-160.00	160.00	%	100.00	327	
P2.2.4.5	A2 Signal Inv	0	1		0	398	0 = No inversion 1 = Inverted
P2.2.4.6	A2 Scale Min	-32000	32000		0	393	
P2.2.4.7	A2 Scale Max	-32000	32000		0	394	
P2.2.4.8	A2 Controll. ID	0	10000		0	1528	

4.2.5 Analog Input 3

Table 10: Analog Input 3

Index	Parameter	Min.	Max.	Unit	Default	ID	Description
P2.2.5.1	A3 Signal Sel	0.1	F.10		0.1	141	
P2.2.5.2	A3 Filter Time	0.000	32.000	s	0.000	142	
P2.2.5.3	A3 Custom Min	-160.00	160.00	%	0.00	144	
P2.2.5.4	A3 Custom Max	-160.00	160.00	%	0.00	145	
P2.2.5.5	A3 Signal Inv	0	1		0	151	0 = No inversion 1 = Inverted
P2.2.5.6	A3 Scale Min	-32000	32000		0	1037	
P2.2.5.7	A3 Scale Max	-32000	32000		0	1038	
P2.2.5.8	A3 Controll. ID	0	10000		0	1529	

4.2.6 Analog Input 4

Table 11: Analog Input 4

Index	Parameter	Min.	Max.	Unit	Default	ID	Description
P2.2.6.1	A4 Signal Sel	0.1	F.10		0.1	152	
P2.2.6.2	A4 Filter Time	0.000	32.000	s	0.000	153	
P2.2.6.3	A4 Custom Min	-160.00	160.00	%	0.00	155	
P2.2.6.4	A4 Custom Max	-160.00	160.00	%	0.00	156	
P2.2.6.5	A4 Signal Inv	0	1		0	162	0 = No inversion 1 = Inverted
P2.2.6.6	A4 Scale Min	-32000	32000		0	1039	
P2.2.6.7	A4 Scale Max	-32000	32000		0	1040	
P2.2.6.8	A4 Controll. ID	0	10000		0	1530	

4.2.7 Options

Table 12: Options

Index	Parameter	Min.	Max.	Unit	Default	ID	Description
P2.2.7.1	INV Commands	0	65535			1091	

4.3 Output Signals

4.3.1 Digital Outputs

Table 13: Digital Outputs

Index	Parameter	Min.	Max.	Unit	Default	ID	Description
P2.3.1.1	Ready	0.1	E.10	DiOut	0.1	432	
P2.3.1.2	Run	0.1	E.10	DiOut	0.1	433	DCGuard is closed

Index	Parameter	Min.	Max.	Unit	Default	ID	Description
P2.3.1.3	Fault	0.1	E.10	DiOut	0.1	434	
P2.3.1.4	Inverted Fault	0.1	E.10	DiOut	0.1	435	
P2.3.1.5	Warning	0.1	E.10	DiOut	0.1	436	
P2.3.1.6	DCGuard Closed	0.1	E.10	DiOut	0.1	445	DCGuard is fully closed
P2.3.1.7	U Cable OK	0.1	E.10	DiOut	0.1	1509	
P2.3.1.8	V Cable OK	0.1	E.10	DiOut	0.1	1510	
P2.3.1.9	W Cable OK	0.1	E.10	DiOut	0.1	1511	
P2.3.1.10	U High Load	0.1	E.10	DiOut	0.1	1512	
P2.3.1.11	V High Load	0.1	E.10	DiOut	0.1	1513	
P2.3.1.12	W High Load	0.1	E.10	DiOut	0.1	1514	
P2.3.1.13	Switch Lock	0.1	E.10	DiOut	0.1	1527	Interlock for mechanical disconnect

4.3.2 Analog Output 1

Table 14: Analog Output 1

Index	Parameter	Min.	Max.	Unit	Default	ID	Description
P2.3.2.1	Analog output 1 signal selection	0.1	E.10		0.1	464	TTF programming ⁽¹⁾
P2.3.2.2	Analog output 1 function	0	20		1	307	0 = Not used (4 mA/2 V) 1 = DCCurrent \pm (-100%...+100% DC-link current)
P2.3.2.3	Analog output 1 filter time	0.00	10.00	s	1.00	308	0 = No filtering
P2.3.2.4	Analog output 1 inversion	0	1		0	309	0 = Not inverted 1 = Inverted
P2.3.2.5	Analog output 1 minimum	0	1		0	310	0 = 0 mA (0%) 1 = 4 mA (20%)
P2.3.2.6	Analog output 1 scale	10	1000	%	100	311	
P2.3.2.7	Analog output 1 offset	-100.00	100.00	%	0.00	375	

¹ See [6.11 "Terminal to Function" \(TTF\) Programming Principle](#).

4.3.3 Analog Output 2

Table 15: Analog Output 2

Index	Parameter	Min.	Max.	Unit	Default	ID	Description
P2.3.3.1	Analog output 2 signal selection	0.1	E.10		0.1	471	TTF programming ⁽¹⁾
P2.3.3.2	Analog output 2 function	0	20		4	472	0 = Not used (4 mA/2 V) 1 = DCCurrent \pm (-100%...+100% DC-link current)
P2.3.3.3	Analog output 2 filter time	0.00	10.00	s	1.00	473	0 = No filtering

Index	Parameter	Min.	Max.	Unit	Default	ID	Description
P2.3.3.4	Analog output 2 inversion	0	1		0	474	0 = Not inverted 1 = Inverted
P2.3.3.5	Analog output 2 minimum	0	1		0	475	0 = 0 mA (0%) 1 = 4 mA (20%)
P2.3.3.6	Analog output 2 scale	10	1000	%	100	476	
P2.3.3.7	Analog output 2 offset	-100.00	100.00	%	0.00	477	

¹ See [6.11 "Terminal to Function" \(TTF\) Programming Principle](#).

4.3.4 Analog Output 3

Table 16: Analog Output 3

Index	Parameter	Min.	Max.	Unit	Default	ID	Description
P2.3.4.1	Analog output 3 signal selection	0.1	E.10		0.1	478	TTF programming ⁽¹⁾
P2.3.4.2	Analog output 3 function	0	20		5	479	0 = Not used (4 mA/2 V) 1 = DCCurrent± (-100%...+100% DC-link current)
P2.3.4.3	Analog output 3 filter time	0.00	10.00	s	1.00	480	0 = No filtering
P2.3.4.4	Analog output 3 inversion	0	1		0	481	0 = Not inverted 1 = Inverted
P2.3.4.5	Analog output 3 minimum	0	1		0	482	0 = 0 mA (0%) 1 = 4 mA (20%)
P2.3.4.6	Analog output 3 scale	10	1000	%	100	483	
P2.3.4.7	Analog output 3 offset	-100.00	100.00	%	0.00	484	

¹ See [6.11 "Terminal to Function" \(TTF\) Programming Principle](#).

4.3.5 Supervision Limit

Table 17: Supervision Limit

Index	Parameter	Min.	Max.	Unit	Default	ID	Description
P2.3.5.1	Switch Lock Current Limit	0	100	%	5%	1862	Limit supervision for P2.3.1.13, ID1527

4.4 Limit Settings

4.4.1 Current Limit

Table 18: Current Limit

Index	Parameter	Min.	Max.	Unit	Default	ID	Description
P2.4.1.1	U Phase Trip Limit	0	300.0	%	150.0	1500	
P2.4.1.2	V Phase Trip Limit	0	300.0	%	150.0	1501	
P2.4.1.3	W Phase Trip Limit	0	300.0	%	150.0	1502	

Index	Parameter	Min.	Max.	Unit	Default	ID	Description
P2.4.1.4	Fast Reclosing	0	1		0	1859	
P2.4.1.5	Prediction Gain	1	1000	%	100.0	673	
P2.4.1.6	SW Trip Response	0	2		1	1874	0 = No Action 1 = Warning information 2 = Fault 3 = Warning, keep control word

4.5 Drive Control Parameters

Table 19: Drive Control Parameters

Index	Parameter	Min.	Max.	Unit	Default	ID	Description
P2.5.1	Switching frequency	1.0	10.0	kHz	5.0	601	Controlled voltage ramp up switching frequency
P2.5.2	Pulse Ratio	0.00	50.00		15.00	606	
P2.5.3	Voltage Rise Time	0	25000	ms	550	1541	
P2.5.4	Control Options 1	0	65535		0	1084	
P2.5.5	Control Options 2	0	65535		0	1798	
P2.5.6	DCG ControlWord				0	1508	
P2.5.7	Start Delay	0.00	10.00	s	0.50	1800	
P2.5.8	Restart Delay	0.001	60.000	s	1.000	1424	

4.5.1 Identification

Table 20: Identification

Index	Parameter	Min.	Max.	Unit	Default	ID	Description
P2.5.9.1	IU Offset	-1000	1000			668	
P2.5.9.2	IV Offset	-1000	1000			669	
P2.5.9.3	IW Offset	-1000	1000			670	

4.6 Master/Follower

Table 21: Master/Follower

Index	Parameter	Min.	Max.	Unit	Default	ID	Description
P2.6.1	MF Mode	0	0			1324	0 = Not in use

4.7 Fieldbus Parameters

Table 22: Fieldbus Parameters

Index	Parameter	Min.	Max.	Unit	Default	ID	Description
P2.7.1	FB Actual Selection	0	65535		73	1853	Select monitoring data with parameter ID Default: DC-Link Power [kW]
P2.7.2	GSW ID	0	65535		65	897	Default: FB Status Word

Index	Parameter	Min.	Max.	Unit	Default	ID	Description
P2.7.3	Fieldbus process data out 1 selection	0	10000		1851	852	Default: U Phase Current
P2.7.4	Fieldbus process data out 2 selection	0	10000		1852	853	Default: V Phase Current
P2.7.5	Fieldbus process data out 3 selection	0	10000		1868	854	Default: W Phase Current
P2.7.6	Fieldbus process data out 4 selection	0	10000		8	855	Default: Unit Temperature
P2.7.7	Fieldbus process data out 5 selection	0	10000		0	856	
P2.7.8	Fieldbus process data out 6 selection	0	10000		0	857	
P2.7.9	Fieldbus process data out 7 selection	0	10000		0	858	
P2.7.10	Fieldbus process data out 8 selection	0	10000		0	859	
P2.7.11	Fieldbus process data in 1 selection	0	10000		0	876	
P2.7.12	Fieldbus process data in 2 selection	0	10000		0	877	
P2.7.13	Fieldbus process data in 3 selection	0	10000		0	878	
P2.7.14	Fieldbus process data in 4 selection	0	10000		0	879	
P2.7.15	Fieldbus process data in 5 selection	0	10000		0	880	
P2.7.16	Fieldbus process data in 6 selection	0	10000		0	881	
P2.7.17	Fieldbus process data in 7 selection	0	10000		0	882	
P2.7.18	Fieldbus process data in 8 selection	0	10000		0	883	
P2.7.19	State Machine	0	2		0	896	0 = Basic 1 = Standard (bypass) 2 = DCGuard 1 (bypass)

4.8 Protections

Table 23: Protections

Index	Parameter	Min.	Max.	Unit	Default	ID	Description
M2.8.1	General						See 4.8.1 General
M2.8.2	U Phase Over Load Protection						See 4.8.2 U Phase Over Load Protection
M2.8.3	V Phase Over Load Protection						See 4.8.3 V Phase Over Load Protection
M2.8.4	W Phase Over Load Protection						See 4.8.4 W Phase Over Load Protection
M2.8.5	U Phase Current protection						See 4.8.5 U Phase Current Protection
M2.8.6	V Phase Current protection						See 4.8.6 V Phase Current Protection
M2.8.7	W Phase Current protection						See 4.8.7 W Phase Current Protection
P2.8.8	Reset Data Logger	0	1		0	1857	0 = No 1 = Yes
P2.8.9	Fault Simulation	0	65535		0	1569	
P2.8.10	Disable Stop Lock	0	1		0	1086	0 = No

Index	Parameter	Min.	Max.	Unit	Default	ID	Description
							1 = Yes

4.8.1 General

Table 24: General

Index	Parameter	Min.	Max.	Unit	Default	ID	Description
P2.8.1.1	Earth Fault Current	0.0	510	%	50	1333	
P2.8.1.2	Vdc Trip Limit	0	1600	V DC	1500	1858	
P2.8.1.3	FB Fault Slot D Response	0	3		2	733	0 = No response 1 = Warning 2 = Fault 3 = Warning, keep control word
P2.8.1.4	KP PC Fault Mode	0	3		0	1329	0 = No response 1 = Warning 2 = Fault 3 = Warning, keep control word

4.8.2 U Phase Over Load Protection

Table 25: U Phase Over Load Protection

Index	Parameter	Min.	Max.	Unit	Default	ID	Description
P2.8.2.1	U Over Load Response	0	2		2	1524	0 = No response 1 = Warning 2 = Fault
P2.8.2.2	Minimum Input	0.0	300.0	%	101.0	1504	
P2.8.2.3	Maximum Input	0.0	300.0	%	130.0	1505	
P2.8.2.4	Maximum Step	0.0	10000		20	1506	

4.8.3 V Phase Over Load Protection

Table 26: V Phase Over Load Protection

Index	Parameter	Min.	Max.	Unit	Default	ID	Description
P2.8.3.1	V Over Load Response	0	2		2	1525	0 = No response 1 = Warning 2 = Fault
P2.8.3.2	Minimum Input	0.0	300.0	%	101.0	1531	
P2.8.3.3	Maximum Input	0.0	300.0	%	130.0	1532	
P2.8.3.4	Maximum Step	0.0	10000		20	1533	

4.8.4 W Phase Over Load Protection

Table 27: W Phase Over Load Protection

Index	Parameter	Min.	Max.	Unit	Default	ID	Description
P2.8.4.1	W Over Load Response	0	2		2	1526	0 = No response 1 = Warning 2 = Fault
P2.8.4.2	Minimum Input	0.0	300.0	%	101.0	1534	
P2.8.4.3	Maximum Input	0.0	300.0	%	130.0	1535	
P2.8.4.4	Maximum Step	0.0	10000		20	1536	

4.8.5 U Phase Current Protection

Table 28: U Phase Current Protection

Index	Parameter	Min.	Max.	Unit	Default	ID	Description
P2.8.5.1	U High Current Response	0	2		0	1550	0 = No Warning, no action 1 = Warning, no action 2 = Warning, the phase with overcurrent is disabled 3 = Fault, the drive is stopped
P2.8.5.2	U Trip Limit	0.0	400.0	%	105.0	1551	
P2.8.5.3	U Trip Delay	0.0	60.0	s	1.00	1552	

4.8.6 V Phase Current Protection

Table 29: V Phase Current Protection

Index	Parameter	Min.	Max.	Unit	Default	ID	Description
P2.8.6.1	V High Current Response	0	2		0	1553	0 = No Warning, no action 1 = Warning, no action 2 = Warning, the phase with overcurrent is disabled 3 = Fault, the drive is stopped
P2.8.6.2	V Trip Limit	0.0	400.0	%	105.0	1554	
P2.8.6.3	V Trip Delay	0.0	60.0	s	1.00	1555	

4.8.7 W Phase Current Protection

Table 30: W Phase Current Protection

Index	Parameter	Min.	Max.	Unit	Default	ID	Description
P2.8.7.1	W High Current Response	0	2		0	1556	0 = No Warning, no action 1 = Warning, no action 2 = Warning, the phase with overcurrent is disabled 3 = Fault, the drive is stopped
P2.8.7.2	W Trip Limit	0.0	400.0	%	105.0	1558	

Index	Parameter	Min.	Max.	Unit	Default	ID	Description
P2.8.7.3	W Trip Delay	0.0	60.0	s	1.00	1559	

4.9 ID Functions

4.9.1 Value Control

Table 31: Value Control

Index	Parameter	Min.	Max.	Unit	Default	ID	Description
P2.9.1.1	Control Mode	0	6		0 / SR ABS	1590	0 = SR ABS 1 = Scale ABS 2 = Scale INV ABS 3 = SR 4 = Scale 5 = Scale INV 6 = XY control
P2.9.1.2	ContrInSignal ID	0	10000	ID	0	1580	
P2.9.1.3	Contrl Off Limit	-32000	32000		0	1581	
P2.9.1.4	Contrl On Limit	-32000	32000		0	1582	
P2.9.1.5	Contrl Off Value	-32000	32000		0	1583	
P2.9.1.6	Contrl On Value	-32000	32000		0	1584	
P2.9.1.7	ControlOutSignID	0	10000	ID	0	1585	
P2.9.1.8	Control Filt TC	0.000	32.000	s	0.000	1721	
P2.9.1.9	X Value 01	-32000	32000		0	1626	
P2.9.1.10	Y Value 01	-32000	32000		0	2001	
P2.9.1.11	X Value 02	-32000	32000		0	1627	
P2.9.1.12	Y Value 02	-32000	32000		0	2002	
P2.9.1.13	X Value 03	-32000	32000		0	1628	
P2.9.1.14	Y Value 03	-32000	32000		0	2003	
P2.9.1.15	X Value 04	-32000	32000		0	1629	
P2.9.1.16	Y Value 04	-32000	32000		0	2004	
P2.9.1.17	X Value 05	-32000	32000		0	1630	
P2.9.1.18	Y Value 05	-32000	32000		0	2005	
P2.9.1.19	X Value 06	-32000	32000		0	1631	
P2.9.1.20	Y Value 06	-32000	32000		0	2006	

4.9.2 DIN ID Control 1

Table 32: DIN ID Control 1

Index	Parameter	Min.	Max.	Unit	Default	ID	Description
P2.9.2.1	ID Control DIN	DigIN:0.1	DigIN:E.10		DigIN:0.1	1570	Slot board input number
P2.9.2.2	Controlled ID	0	10000	ID	0	1571	Select ID that is controlled by digital input
P2.9.2.3	FALSE Value	-32000	32000		0	1572	Value when DI is low
P2.9.2.4	TRUE Value	-32000	32000		0	1573	Value when DI is high

4.9.3 DIN ID Control 2

Table 33: DIN ID Control 2

Index	Parameter	Min.	Max.	Unit	Default	ID	Description
P2.9.3.1	ID Control DIN	DigIN:0.1	DigIN:E.10		DigIN:0.1	1574	Slot board input number
P2.9.3.2	Controlled ID	0	10000	ID	0	1575	Select ID that is controlled by digital input
P2.9.3.3	FALSE Value	-32000	32000		0	1576	Value when DI is low
P2.9.3.4	TRUE Value	-32000	32000		0	1577	Value when DI is high

4.9.4 DIN ID Control 3

Table 34: DIN ID Control 3

Index	Parameter	Min.	Max.	Unit	Default	ID	Description
P2.9.4.1	ID Control DIN	DigIN:0.1	DigIN:E.10		DigIN:0.1	1578	Slot board input number
P2.9.4.2	Controlled ID	0	10000	ID	0	1579	Select ID that is controlled by digital input
P2.9.4.3	FALSE Value	-32000	32000		0	1587	Value when DI is low
P2.9.4.4	TRUE Value	-32000	32000		0	1588	Value when DI is high

4.10 Keypad Control

Table 35: Keypad Control

Index	Parameter	Min.	Max.	Unit	Default	ID	Description
P3.1	Control place	0	2		2	125	0 = Fieldbus 1 = I/O terminal 2 = Keypad
P3.2	License Key	0	65535		0	1995	
P3.3	Enable KP Open	0	1		0	1864	0 = Disable 1 = Enable
P3.4	Enable KP Close	0	1		0	1863	0 = Disable 1 = Enable

4.11 System Menu (Control Panel: Menu M6)

For more information related to the general use of the AC drive, such as selecting application and language, customized parameter sets, or hardware and software, see the User Manual of the product.

4.12 Expander Boards (Control Panel: Menu M7)

The *M7* menu shows the expander and option boards attached to the control board and board-related information. For more information, see the User Manual of the product.

5 Monitoring Value Descriptions

5.1 Monitoring 1 Values

5.1.1 (ID 3) DC-Link Amps

Location in the menu: **V1.1.1**

This monitoring value shows the measured DC-link current in amperes. The accuracy of the shown current value depends on the nominal current of the drive.

Table 36: Accuracy of the Monitoring Value

Nominal voltage	Drive rating	Accuracy of monitoring value
380–500 V AC	NX0003–NX0007	0.01 A
	NX0009–NX0300	0.1 A
	NX0385–NX2643	1 A
525–690 V AC	NX0004–NX0013	0.01 A
	NX0018–NX0261	0.1 A
	NX0325–NX1500	1 A

5.1.2 (ID 1861) DC-Link Current

Location in the menu: **V1.1.2**

This monitoring value shows the calculated DC-link current in %.

- *DC-Link Current* > 0: Current is flowing from the DC-link side to the motor phase side.
- *DC-Link Current* < 0: Current is flowing from the motor phase side to the DC-link side.

The definition for 100% current:

- Air-cooled drives: 100% current = I_L
- Liquid-cooled drives: 100% current = I_{TH}

5.1.3 (ID 1108) DC-Link Voltage

Location in the menu: **V1.1.3**

This monitoring value shows the measured DC-link voltage in V DC.

5.1.4 (ID 8) Unit Temperature

Location in the menu: **V1.1.4**

This monitoring value shows the measured heat sink temperature of the drive.

5.1.5 (ID 73) Power kW

Location in the menu: **V1.1.5**

This monitoring value shows the calculated value of the power flow in kW. The accuracy of the shown power value depends on the nominal current of the drive.

Table 37: Accuracy of the Monitoring Value

Nominal voltage	Drive rating	Accuracy of monitoring value
380–500 V AC	NX0003	0.01 kW
	NX0004–NX0205	0.1 kW
	NX0261–NX2643	1 kW
525–690 V AC	NX0004–NX0005	0.01 kW

Nominal voltage	Drive rating	Accuracy of monitoring value
	NX0007–NX0170	0.1 kW
	NX0208–NX1500	1 kW

5.1.6 (ID 5) DC-Link Power

Location in the menu: **V1.1.6**

This monitoring value shows the calculated power in % of the nominal power. The value shows 100% when at unit nominal current and at nominal DC-link voltage.

The definition for nominal DC-link voltage:

- 500 V units: 675 V (1.35 × 500 V)
- 690 V units: 931 V (1.35 × 690 V)

5.1.7 (ID 26) Analog Output 1

Location in the menu: **V1.1.7**

This monitoring value shows the status of the *Analog output 1* in %.

- 0% = 0 mA / 0 V
- 100% = 20 mA / 10 V

5.1.8 (ID 31) Analog Output 2

Location in the menu: **V1.1.8**

This monitoring value shows the status of the *Analog output 2* in %.

- 0% = 0 mA / 0 V
- 100% = 20 mA / 10 V

5.1.9 (ID 32) Analog Output 3

Location in the menu: **V1.1.9**

This monitoring value shows the status of the *Analog output 3* in %.

- 0% = 0 mA / 0 V
- 100% = 20 mA / 10 V

5.2 Monitoring 2 Values

5.2.1 (ID 44) DC Voltage

Location in the menu: **V1.2.1**

This monitoring value shows the unfiltered DC-link voltage in V.

5.2.2 (ID 1851) U Phase Current

Location in the menu: **V1.2.2**

This monitoring value shows the measured U phase current in amperes. The accuracy of the shown current value depends on the nominal current of the drive.

Table 38: Accuracy of the Monitoring Value

Nominal voltage	Drive rating	Accuracy of monitoring value
380–500 V AC	NX0003–NX0007	0.01 A
	NX0009–NX0300	0.1 A
	NX0385–NX2643	1 A
525–690 V AC	NX0004–NX0013	0.01 A

Nominal voltage	Drive rating	Accuracy of monitoring value
	NX0018–NX0261	0.1 A
	NX0325–NX1500	1 A

5.2.3 (ID 1852) V Phase Current

Location in the menu: **V1.2.3**

This monitoring value shows the measured V phase current in amperes. The accuracy of the shown current value depends on the nominal current of the drive.

See [5.2.2 \(ID 1851\) U Phase Current](#).

5.2.4 (ID 1853) W Phase Current

Location in the menu: **V1.2.4**

This monitoring value shows the measured W phase current in amperes. The accuracy of the shown current value depends on the nominal current of the drive.

See [5.2.2 \(ID 1851\) U Phase Current](#).

5.2.5 (ID 1871) U Phase Power

Location in the menu: **V1.2.5**

This monitoring value shows the value of the power flow in phase U. The accuracy of the shown power value depends on the nominal current of the drive.

Table 39: Accuracy of the Monitoring Value

Nominal voltage	Drive rating	Accuracy of monitoring value
380–500 V AC	NX0003–NX0007	0.01 kW
	NX0009–NX0300	0.1 kW
	NX0385–NX2643	1 kW
525–690 V AC	NX0004–NX0013	0.01 kW
	NX0018–NX0261	0.1 kW
	NX0325–NX1500	1 kW

5.2.6 (ID 1872) V Phase Power

Location in the menu: **V1.2.6**

This monitoring value shows the value of the power flow in phase V. The accuracy of the shown power value depends on the nominal current of the drive.

See [5.2.5 \(ID 1871\) U Phase Power](#).

5.2.7 (ID 1873) W Phase Power

Location in the menu: **V1.2.7**

This monitoring value shows the value of the power flow in phase W. The accuracy of the shown power value depends on the nominal current of the drive.

See [5.2.5 \(ID 1871\) U Phase Power](#).

5.2.8 (ID 43) Status Word

Location in the menu: **V1.2.8**

This monitoring value shows the bit-coded status of the AC drive. The application status word combines different drive status values to one data word.

See [6.12 Fieldbus Control In Detail](#).

Table 40: Status Word Description

Bit	False	True
b0		
b1	Not in ready state	Ready
b2	Not running (open)	Running (closed)
b3	No fault	Fault
b4		
b5		
b6	Run disabled (close disabled)	Run enabled (close enabled)
b7	No warning	Warning
b8		
b9		
b10		
b11		
b12	No run request (no close request)	Run request (close request)
b13		
b14	DCGuard open	DCGuard closed
b15		

5.2.9 (ID 56) DIN Status 1

Location in the menu: **V1.2.9**

This monitoring value shows the bit-coded status of the digital input signals.

Table 41: DIN Status 1 Description

Bit	DIN Status Word 1	DIN Status Word 2
b0	DIN: A.1	DIN: C.5
b1	DIN: A.2	DIN: C.6
b2	DIN: A.3	DIN: D.1
b3	DIN: A.4	DIN: D.2
b4	DIN: A.5	DIN: D.3
b5	DIN: A.6	DIN: D.4
b6	DIN: B.1	DIN: D.5
b7	DIN: B.2	DIN: D.6
b8	DIN: B.3	DIN: E.1
b9	DIN: B.4	DIN: E.2
b10	DIN: B.5	DIN: E.3

Bit	DIN Status Word 1	DIN Status Word 2
b11	DIN: B.6	DIN: E.4
b12	DIN: C.1	DIN: E.5
b13	DIN: C.2	DIN: E.6
b14	DIN: C.3	
b15	DIN: C.4	

5.2.10 (ID 57) DIN Status 2

Location in the menu: **V1.2.10**

This monitoring value shows the bit-coded status of the digital input signals.

See [5.2.9 \(ID 56\) DIN Status 1](#).

5.2.11 (ID 1869) DCGuard Status Word

Location in the menu: **V1.2.11**

This monitoring value shows the bit-coded status of the diagnostic signals for the DCGuard.

Table 42: DCGuard Status Word Description

Bit	Function	Notes
b0	U phase active	
b1	V phase active	
b2	W phase active	
b3	U phase fault	
b4	V phase fault	
b5	W phase fault	
b6	Cutter active	Reserved for testing purposes
b7	I sum trip	Reserved for testing purposes
b8	F1 masked	Reserved for testing purposes
b9	U phase state	Reserved for testing purposes
b10	V phase state	Reserved for testing purposes
b11	W phase state	Reserved for testing purposes
b12		
b13		
b14		
b15		

5.2.12 (ID 1870) DCGuard Control Status

Location in the menu: **V1.2.12**

This monitoring value shows the bit-coded status of the control commands from the DCGuard application software to the system software.

Table 43: DCGuard Control Status Description

Bit	Function	Notes
b0	On command U phase	
b1	On command V phase	
b2	On command W phase	
b3	Fault reset U phase	
b4	Fault reset V phase	
b5	Fault reset W phase	
b6	Disable SD start	Reserved for testing purposes
b7	Disable ramp	Reserved for testing purposes
b8	Disable sequence charge	Reserved for testing purposes
b9		
b10		
b11		
b12		
b13		
b14		
b15		

5.2.13 (ID 97) Data Logger Trigger Word

Location in the menu: **V1.2.13**

This monitoring value shows the bit-coded trigger values of the data logger.

Table 44: Data Logger Trigger Word Description

Bit	Function	Notes
b0	Fault status	The data logger is triggered when there is a fault.
b1	Warning status	The data logger is triggered when there is a warning.
b2	Auto-reset warning	The data logger is triggered when there is a fault that has been defined to be automatically reset. This bit can be used to get the first fault situation.
b3	Fault status OR Warning status	B0 or B1 triggering situation has happened.
b4	Fault status OR Auto-reset warning	B0 or B2 triggering situation has happened.
b5		
b6		
b7		
b8		
b9		
b10		

Bit	Function	Notes
b11		
b12		
b13		
b14		
b15		

5.3 Fieldbus Monitoring Values

5.3.1 (ID 1160) Fieldbus Control Word

Location in the menu: **V1.3.1**

This monitoring value shows the bit-coded status of the fieldbus control word. See [6.12 Fieldbus Control In Detail](#).

5.3.2 (ID 65) Fieldbus Status Word

Location in the menu: **V1.3.2**

This monitoring value shows the bit-coded status of the fieldbus status word. See [6.12 Fieldbus Control In Detail](#).

5.3.3 (ID 37) Last Active Fault

Location in the menu: **V1.3.3**

This monitoring value shows the fault code of the latest activated fault that is not reset.

5.3.4 (ID 74) Last Active Alarm

Location in the menu: **V1.3.4**

This monitoring value shows the fault code of the latest activated alarm that is not reset.

5.3.5 (ID 1172) Fault Word 1

Location in the menu: **V1.3.5**

This monitoring value shows the bit-coded status of the *Fault Word 1*.

Table 45: Fault Word 1 Description

Bit	False	True
b0		F31 IGBT temperature F41 IGBT temperature
b1		F2 Overvoltage fault
b2		F9 Undervoltage fault
b3		F1 Overcurrent fault
b4		F66 UV phase overcurrent
b5		F73 VW phase overcurrent
b6		F70 UVW phase overcurrent
b7		F63 U phase overcurrent
b8		F64 V phase overcurrent
b9		F65 W phase overcurrent

Bit	False	True
b10		F83 U phase overload F84 V phase overload F85 W phase overload
b11		F52 Keypad communication fault F52 PC communication fault
b12		F53 Fieldbus communication fault
b13		F59 System bus communication fault ⁽¹⁾
b14		F54 Slot fault
b15		F14 Drive overtemperature

¹ Not used.

5.3.6 (ID 1174) Alarm Word 1

Location in the menu: V1.3.6

This monitoring value shows the bit-coded status of the *Alarm Word 1*.

Table 46: Alarm Word 1 Description

Bit	False	True
b0		
b1		
b2		
b3		
b4		
b5		
b6		
b7		
b8		
b9		
b10		F83 U phase overload F84 V phase overload F85 W phase overload
b11		
b12		
b13		
b14		
b15		F14 Drive overtemperature

6 Parameter Descriptions

6.1 Basic Parameters

6.1.1 (ID 1503) Cabling

Location in the menu: **P2.1.1**

Use this parameter to select the cabling type of the DCGuard unit. Select the parameter according to the cabling set-up used in the peer-to-peer installation. The available options are:

- 0 = Not selected
The default setting. Drive operation is disabled.
- 1 = Three cable connection, U = DC+, V = DC-, W = DC+

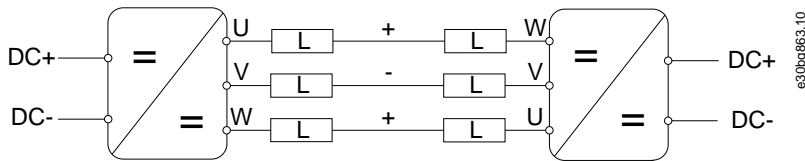

Illustration 4: DCGuard Three Cable Connection

- 2 = Two cable connection, U = DC+, V = DC-, W = not connected

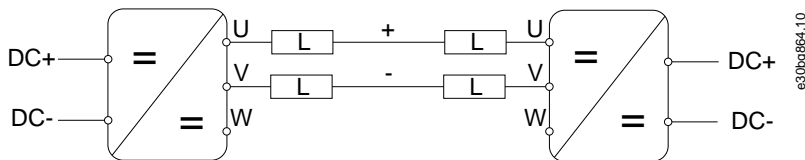

Illustration 5: DCGuard Two Cable Connection with Phases U and V

- 3 = Two cable connection, V = DC-, W = DC+, U = not connected

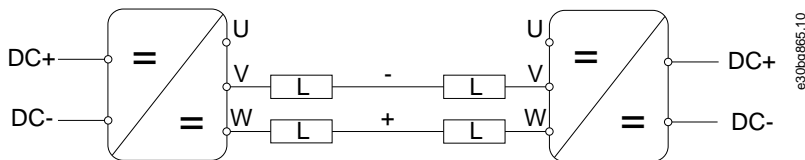

Illustration 6: DCGuard Two Cable Connection with Phases V and W

In a two cable peer-to-peer system, it is recommended to use the following set-up for the DCGuard units:

- DCGuard 1: U = DC+, V = DC-, W = not connected
- Cabling type 2
- DCGuard 2: V = DC-, W = DC+, U = not connected
- Cabling type 3

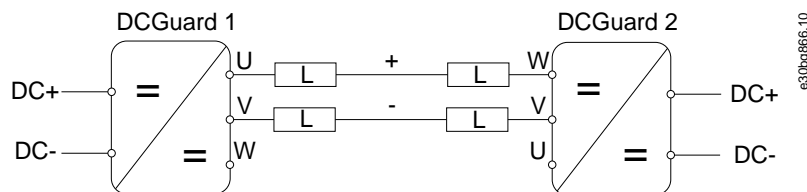

Illustration 7: The Recommended DCGuard Two Cable Connection

6.2 Input Signals

6.2.1 Basic Settings

6.2.1.1 (ID 300) Start/Stop Logic Selection

Location in the menu: **P2.2.1.1**

Use this parameter to define the start/stop logic of the drive when using the I/O controls.

0 "Start-No act" – Forward Start

- DIN1: closed contact = start forward DI "Start 1"
- DIN2: closed contact = no action

1 "RPuls-No act" – Forward start rising edge

- DIN1: closed contact = start forward (Rising edge required to start)
- DIN2: closed contact = no action

2 "RPuls-RPuls" – Start rising edge – Stop rising edge

- DIN1: closed contact = Start (Rising edge required to start)
- DIN2: closed contact = Stop (Rising edge required to stop)

6.2.2 Digital Inputs

6.2.2.1 (ID 403) Start Signal 1

Location in the menu: **P2.2.2.1**

Use this parameter to select the digital input signal (*Start signal 1*) that starts and stops the drive. This parameter is used to select the input for:

- Switch closed: Run Request signal (Close command)
- Switch open: Stop Request signal (Open command)

6.2.2.2 (ID 404) Start Signal 2

Location in the menu: **P2.2.2.2**

Use this parameter to select the digital input signal (*Start signal 2*) that starts and stops the drive. This parameter is used to select the input for:

- Switch closed: Run Request signal (Close command)
- Switch open: Stop Request signal (Open command)

6.2.2.3 (ID 407) Run Enable 1

Location in the menu: **P2.2.2.3**

Use this parameter to select the digital input signal that sets the drive to Ready state.

When the signal is low, the DCGuard loses READY status.

- Switch open: Closing of the DCGuard is disabled. If already closed, also opens the DCGuard.
- Switch closed: Closing of the DCGuard is enabled.

6.2.2.4 (ID 1860) Run Enable 2

Location in the menu: **P2.2.2.4**

Use this parameter to select the digital input signal that sets the drive to Ready state.

When the signal is low, the DCGuard loses READY status.

- Switch open: Closing of the DCGuard is disabled.
- Switch closed: Closing of the DCGuard is enabled.

6.2.2.5 (ID 414) Fault Reset

Location in the menu: **P2.2.2.5**

Use this parameter to select the digital input signal that resets all active faults.

CLOSED = Resets all active faults. Rising edge resets the faults.

6.2.2.6 (ID 405) External Fault 1

Location in the menu: **P2.2.2.6**

Use this parameter to select the digital input signal that activates an external fault.

Switch open: Fault 51 is shown and the motor stopped.

6.2.2.7 (ID 406) External Fault 2

Location in the menu: **P2.2.2.7**

Use this parameter to select the digital input signal that activates an external fault.

Switch open: Fault 81 is shown and the motor stopped.

6.2.2.8 (ID 1515) Enable U

Location in the menu: **P2.2.2.8**

Use this parameter to select the digital input signal that enables U phase operation.

The parameter is used for an interlock from the other unit that is operating in bridge mode to stop the current flow.

6.2.2.9 (ID 1516) Enable V

Location in the menu: **P2.2.2.9**

Use this parameter to select the digital input signal that enables V phase operation.

The parameter is used for an interlock from the other unit that is operating in bridge mode to stop the current flow.

6.2.2.10 (ID 1517) Enable W

Location in the menu: **P2.2.2.10**

Use this parameter to select the digital input signal that enables W phase operation.

The parameter is used for an interlock from the other unit that is operating in bridge mode to stop the current flow.

6.2.2.11 (ID 1518) Reset U

Location in the menu: **P2.2.2.11**

Use this parameter to select the digital input signal that resets only the fault for phase U.

6.2.2.12 (ID 1520) Reset V

Location in the menu: **P2.2.2.12**

Use this parameter to select the digital input signal that resets only the fault for phase V.

6.2.2.13 (ID 1519) Reset W

Location in the menu: **P2.2.2.13**

Use this parameter to select the digital input signal that resets only the fault for phase W.

6.2.2.14 (ID 1521) Overload U

Location in the menu: **P2.2.2.14**

Use this parameter to select the digital input signal to indicate overload on this phase from the U phase of an adjacent drive.

6.2.2.15 (ID 1522) Overload V

Location in the menu: **P2.2.2.15**

Use this parameter to select the digital input signal to indicate overload on this phase from the V phase of an adjacent drive.

6.2.2.16 (ID 1523) Overload W

Location in the menu: **P2.2.2.16**

Use this parameter to select the digital input signal to indicate overload on this phase from the W phase of an adjacent drive.

6.2.2.17 (ID 409) I/O Terminal Control

Location in the menu: **P2.2.2.17**

Use this parameter to select the digital input signal that switches the control place and the frequency reference source to I/O terminal (from any control place).

Switch closed: Force control place to I/O terminal.

This input has priority over parameters ID 410 and ID 411.

6.2.2.18 (ID 410) Keypad Control

Location in the menu: **P2.2.2.18**

Use this parameter to select the digital input signal that switches the control place and the frequency reference source to Keypad (from any control place).

Switch closed: Force control place to keypad.

This input has priority over parameter ID 411 but preceded in priority by ID 409.

6.2.2.19 (ID 411) Fieldbus Control

Location in the menu: **P2.2.2.19**

Use this parameter to select the digital input signal that switches the control place and the frequency reference source to Fieldbus (from I/O A, I/O B or local control).

Switch closed: Force control place to fieldbus.

This input is preceded in priority by parameters ID409 and ID410.

6.2.3 Analog Inputs

6.2.3.1 Analog Input Functions

Analog inputs can be written from the fieldbus. Use of analog scaling for fieldbus signals can be useful, for example, when the PLC is not operational and the drive receives a zero, for example, to the power limit. With analog input scaling, it is possible to use inverted signals and have 100% power limit for emergency run, while the power limit value from PLC is zero.

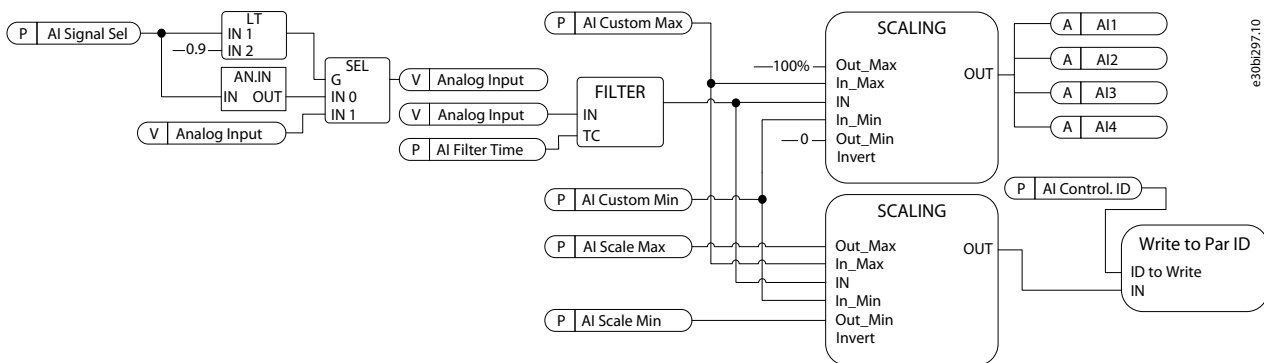

Illustration 8: Analog Input Logic Diagram

6.2.3.2 Analog Input to any Parameter

This function allows control of any parameter by using an analog input. The parameter selects the range of the control area and the ID number for the parameter that is controlled.

To use the function:

- Set the AI Scale Minimum.
- Set the AI Scale Maximum.
- Set the Controlled ID.

6.2.3.3 Analog Input 1

6.2.3.3.1 (ID 377) AI1 Signal Selection

Location in the menu: **P2.2.3.1**

Use this parameter to connect the AI signal to the analog input of your selection.

TTF programming method must be applied to this parameter see [6.11 "Terminal to Function" \(TTF\) Programming Principle](#).

When AI1 Signal Selection is set to 0.1, the AI monitoring variable can be controlled from the fieldbus by assigning the Process Data Input ID number to the AI monitoring signal. This allows the PLC input signals to be scaled with analog input scaling functions.

6.2.3.3.2 (ID 324) AI1 Signal Filter Time

Location in the menu: **P2.2.3.2**

Use this parameter to filter out disturbances in the analog input signal.

First order filtering is used for the analog input signals.

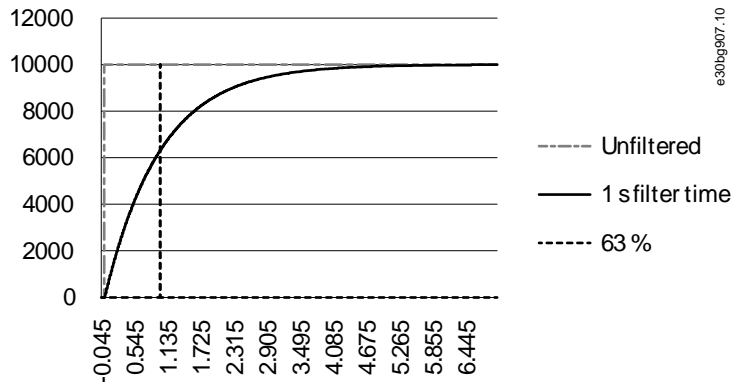

Illustration 9: Analog Input Signal Filtering

6.2.3.3.3 (ID 321) AI1 Custom Setting Minimum

Location in the menu: **P2.2.3.3**

Use this parameter to adjust the minimum value of the analog input signal between -160%...160%.

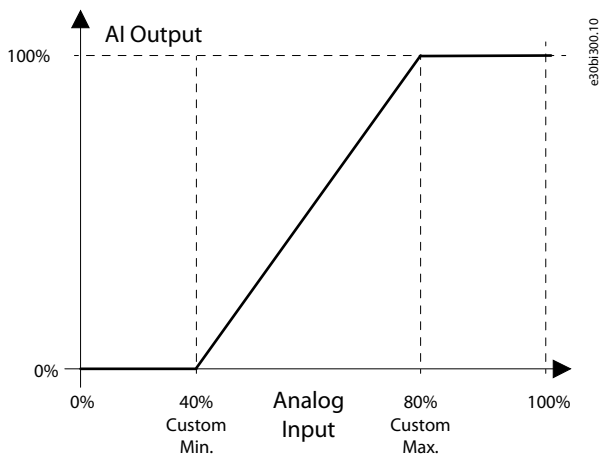

Illustration 10: AI Custom Setting Minimum and Maximum

6.2.3.3.4 (ID 322) AI1 Custom Setting Maximum

Location in the menu: **P2.2.3.4**

Use this parameter to adjust the maximum value of the analog input signal between -160%...160%.

See [Illustration 10](#).

6.2.3.3.5 (ID 387) AI1 Signal Inversion

Location in the menu: **P2.2.3.5**

The signal inversion function is useful if, for example, the PLC is sending power limit to the drive using fieldbus. If the PLC is unable to communicate with the drive, the power limit from the fieldbus to the drive would be zero. Using an inverted signal logic zero value from PLC would mean maximum power limit. When inversion is needed for the process data signal, fieldbus values must be written to analog input monitoring signals. For more information, see [6.2.3.3.1 \(ID 377\) AI1 Signal Selection](#).

Parameter values:

- 0 = No inversion
- 1 = Signal inverted

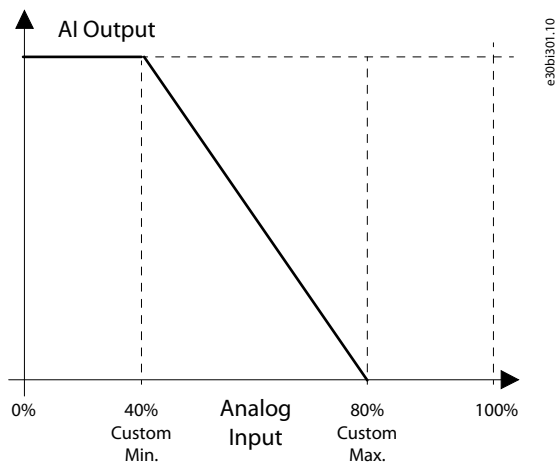

Illustration 11: AI Signal Inversion

6.2.3.3.6 (ID 303) AI1 Scale Minimum

Location in the menu: **P2.2.3.6**

Use this parameter to set the minimum value for the range of the controlled parameter. The decimals are handled as integers. For example, 100.00 must be set as 10000.

6.2.3.3.7 (ID 304) AI1 Scale Maximum

Location in the menu: **P2.2.3.7**

Use this parameter to set the maximum value for the range of the controlled parameter. The decimals are handled as integers. For example, 100.00 must be set as 10000.

6.2.3.3.8 (ID 1507) AI1 Controlled ID

Location in the menu: **P2.2.3.8**

Use this parameter to select the parameter ID controlled with Analog Input 1.

6.2.3.4 Analog Input 2

6.2.3.4.1 (ID 388) AI2 Signal Selection

Location in the menu: **P2.2.4.1**

Use this parameter to connect the AI signal to the analog input of your selection.

TTF programming method must be applied to this parameter see [6.11 "Terminal to Function" \(TTF\) Programming Principle](#).

When AI1 Signal Selection is set to 0.1, the AI monitoring variable can be controlled from the fieldbus by assigning the Process Data Input ID number to the AI monitoring signal. This allows the PLC input signals to be scaled with analog input scaling functions.

6.2.3.4.2 (ID 329) AI2 Signal Filter Time

Location in the menu: **P2.2.4.2**

Use this parameter to filter out disturbances in the analog input signal.

First order filtering is used for the analog input signals.

See [Illustration 9](#).

6.2.3.4.3 (ID 326) AI2 Custom Setting Minimum

Location in the menu: **P2.2.4.3**

Use this parameter to adjust the minimum value of the analog input signal between -160%...160%.

See [Illustration 10](#).

6.2.3.4.4 (ID 327) AI2 Custom Setting Maximum

Location in the menu: **P2.2.4.4**

Use this parameter to adjust the maximum value of the analog input signal between -160%...160%.

See [Illustration 10](#).

6.2.3.4.5 (ID 398) AI2 Signal Inversion

Location in the menu: **P2.2.4.5**

The signal inversion function is useful if, for example, the PLC is sending power limit to the drive using fieldbus. If the PLC is unable to communicate with the drive, the power limit from the fieldbus to the drive would be zero. Using an inverted signal logic zero value from PLC would mean maximum power limit. When inversion is needed for the process data signal, fieldbus values must be written to analog input monitoring signals. For more information, see [6.2.3.3.1 \(ID 377\) AI1 Signal Selection](#).

Parameter values:

- 0 = No inversion
- 1 = Signal inverted

See [Illustration 11](#).

6.2.3.4.6 (ID 393) AI2 Scale Minimum

Location in the menu: **P2.2.4.6**

Use this parameter to set the minimum value for the range of the controlled parameter. The decimals are handled as integers. For example, 100.00 must be set as 10000.

6.2.3.4.7 (ID 394) AI2 Scale Maximum

Location in the menu: **P2.2.4.7**

Use this parameter to set the maximum value for the range of the controlled parameter. The decimals are handled as integers. For example, 100.00 must be set as 10000.

6.2.3.4.8 (ID 1528) AI2 Controlled ID

Location in the menu: **P2.2.4.8**

Use this parameter to select the parameter ID controlled with Analog Input 2.

6.2.3.5 Analog Input 3

6.2.3.5.1 (ID 141) AI3 Signal Selection

Location in the menu: **P2.2.5.1**

Use this parameter to connect the AI signal to the analog input of your selection.

TTF programming method must be applied to this parameter see [6.11 "Terminal to Function" \(TTF\) Programming Principle](#).

When AI1 Signal Selection is set to 0.1, the AI monitoring variable can be controlled from the fieldbus by assigning the Process Data Input ID number to the AI monitoring signal. This allows the PLC input signals to be scaled with analog input scaling functions.

6.2.3.5.2 (ID 142) AI3 Signal Filter Time

Location in the menu: **P2.2.5.2**

Use this parameter to filter out disturbances in the analog input signal.

First order filtering is used for the analog input signals.

See [Illustration 9](#).

6.2.3.5.3 (ID 144) AI3 Custom Setting Minimum

Location in the menu: **P2.2.5.3**

Use this parameter to adjust the minimum value of the analog input signal between -160%...160%.

See [Illustration 10](#).

6.2.3.5.4 (ID 145) AI3 Custom Setting Maximum

Location in the menu: **P2.2.5.4**

Use this parameter to adjust the maximum value of the analog input signal between -160%...160%.

See [Illustration 10](#).

6.2.3.5.5 (ID 151) AI3 Signal Inversion

Location in the menu: **P2.2.5.5**

The signal inversion function is useful if, for example, the PLC is sending power limit to the drive using fieldbus. If the PLC is unable to communicate with the drive, the power limit from the fieldbus to the drive would be zero. Using an inverted signal logic zero value from PLC would mean maximum power limit. When inversion is needed for the process data signal, fieldbus values must be written to analog input monitoring signals. For more information, see [6.2.3.3.1 \(ID 377\) AI1 Signal Selection](#).

Parameter values:

- 0 = No inversion
- 1 = Signal inverted

See [Illustration 11](#).

6.2.3.5.6 (ID 1037) AI3 Scale Minimum

Location in the menu: **P2.2.5.6**

Use this parameter to set the minimum value for the range of the controlled parameter. The decimals are handled as integers. For example, 100.00 must be set as 10000.

6.2.3.5.7 (ID 1038) AI3 Scale Maximum

Location in the menu: **P2.2.5.7**

Use this parameter to set the maximum value for the range of the controlled parameter. The decimals are handled as integers. For example, 100.00 must be set as 10000.

6.2.3.5.8 (ID 1529) AI3 Controlled ID

Location in the menu: **P2.2.5.8**

Use this parameter to select the parameter ID controlled with Analog Input 3.

6.2.3.6 Analog Input 4

6.2.3.6.1 (ID 152) AI4 Signal Selection

Location in the menu: **P2.2.6.1**

Use this parameter to connect the AI signal to the analog input of your selection.

TTF programming method must be applied to this parameter see [6.11 "Terminal to Function" \(TTF\) Programming Principle](#).

When AI1 Signal Selection is set to 0.1, the AI monitoring variable can be controlled from the fieldbus by assigning the Process Data Input ID number to the AI monitoring signal. This allows the PLC input signals to be scaled with analog input scaling functions.

6.2.3.6.2 (ID 153) AI4 Signal Filter Time

Location in the menu: **P2.2.6.2**

Use this parameter to filter out disturbances in the analog input signal.

First order filtering is used for the analog input signals.

See [Illustration 9](#).

6.2.3.6.3 (ID 155) AI4 Custom Setting Minimum

Location in the menu: **P2.2.6.3**

Use this parameter to adjust the minimum value of the analog input signal between -160%...160%.

See [Illustration 10](#).

6.2.3.6.4 (ID 156) AI4 Custom Setting Maximum

Location in the menu: **P2.2.6.4**

Use this parameter to adjust the maximum value of the analog input signal between -160%...160%.

See [Illustration 10](#).

6.2.3.6.5 (ID 162) AI4 Signal Inversion

Location in the menu: **P2.2.6.5**

The signal inversion function is useful if, for example, the PLC is sending power limit to the drive using fieldbus. If the PLC is unable to communicate with the drive, the power limit from the fieldbus to the drive would be zero. Using an inverted signal logic zero value from PLC would mean maximum power limit. When inversion is needed for the process data signal, fieldbus values must be written to analog input monitoring signals. For more information, see [6.2.3.3.1 \(ID 377\) AI1 Signal Selection](#).

Parameter values:

- 0 = No inversion
- 1 = Signal inverted

See [Illustration 11](#).

6.2.3.6.6 (ID 1039) AI4 Scale Minimum

Location in the menu: **P2.2.6.6**

Use this parameter to set the minimum value for the range of the controlled parameter. The decimals are handled as integers. For example, 100.00 must be set as 10000.

6.2.3.6.7 (ID 1040) AI4 Scale Maximum

Location in the menu: **P2.2.6.7**

Use this parameter to set the maximum value for the range of the controlled parameter. The decimals are handled as integers. For example, 100.00 must be set as 10000.

6.2.3.6.8 (ID 1530) AI4 Controlled ID

Location in the menu: **P2.2.6.8**

Use this parameter to select the parameter ID controlled with Analog Input 4.

6.2.4 Options

6.2.4.1 (ID 1091) INV Commands

Location in the menu: **P2.2.7.1**

Use this parameter to select which input signal operation is inverted.

Table 47: Selections for Parameter ID 1091

Selection	Description
B00 (+1)	Invert external fault 1
B01 (+2)	Invert external fault 2

6.3 Output Signals

6.3.1 Digital Outputs

6.3.1.1 (ID 432) Ready

Location in the menu: **P2.3.1.1**

Use this parameter to select a digital output for the *Ready* status.

Ready status: DCGuard is ready to be closed.

6.3.1.2 (ID 433) Run

Location in the menu: **P2.3.1.2**

Run status: The DCGuard is closed.

This signal goes high when the DCGuard is starting to ramp up the output voltage.

6.3.1.3 (ID 434) Fault

Location in the menu: **P2.3.1.3**

Fault status: The DCGuard is in fault state.

6.3.1.4 (ID 435) Inverted Fault

Location in the menu: **P2.3.1.4**

Inverted fault status: No active faults.

6.3.1.5 (ID 436) Warning

Location in the menu: **P2.3.1.5**

Warning status: General warning signal.

6.3.1.6 (ID 445) DCGuard Closed

Location in the menu: **P2.3.1.6**

Use this parameter to select a digital output for the *DCGuard closed* status.

DCGuard closed status: Voltage has been ramped up and the DCGuard is fully closed.

6.3.1.7 (ID 1509) U Cable OK

Location in the menu: **P2.3.1.7**

Use this parameter to select a digital output for the *U cable OK* status.

U cable OK: The U phase is operating and has not reached the overload tripping limit. Can be overloading but has not reached the tripping limit. The signal goes low when the tripping limit is reached.

6.3.1.8 (ID 1510) V Cable OK

Location in the menu: **P2.3.1.8**

Use this parameter to select a digital output for the *V cable OK* status.

V cable OK: The V phase is operating and has not reached the overload tripping limit. Can be overloading but has not reached the tripping limit. The signal goes low when the tripping limit is reached.

6.3.1.9 (ID 1511) W Cable OK

Location in the menu: **P2.3.1.9**

Use this parameter to select a digital output for the *W cable OK* status.

W cable OK: The W phase is operating and has not reached the overload tripping limit. Can be overloading but has not reached the tripping limit. The signal goes low when the tripping limit is reached.

6.3.1.10 (ID 1512) U High Load

Location in the menu: **P2.3.1.10**

Use this parameter to select a digital output for the *U High Load* status.

U High Load: The U phase is loaded more than defined in the minimum overload value P2.8.2.2 Minimum Input.

6.3.1.11 (ID 1513) V High Load

Location in the menu: **P2.3.1.11**

Use this parameter to select a digital output for the *V High Load* status.

V High Load: The V phase is loaded more than defined in the minimum overload value P2.8.3.2 Minimum Input.

6.3.1.12 (ID 1514) W High Load

Location in the menu: **P2.3.1.12**

Use this parameter to select a digital output for the *W High Load* status.

W High Load: The W phase is loaded more than defined in the minimum overload value P2.8.4.2 Minimum Input.

6.3.1.13 (ID 1527) Switch Lock

Location in the menu: **P2.3.1.13**

Use this parameter to select a digital output for the mechanical disconnecter interlocking.

- 0 = DCGuard open **and** DC-link current < Switch Lock Current Limit (ID1862)
- 1 = DCGuard closed **or** DC-link current > Switch Lock Current Limit (ID1862)

6.3.2 Analog Outputs

6.3.2.1 Parameter Set-up Examples

Example

Parameter set-up for a 0–20 mA analog output signal (to *Analog Output 1*):

- P2.3.2.1 = AnOUT:A.1
- P2.3.2.2 = 1 (DCCurrent±)
- P2.3.2.3 = 1.00 s
- P2.3.2.4 = 0 (Not inverted)
- P2.3.2.5 = 0 (0 mA)
- P2.3.2.6 = 50%

Example

Parameter set-up for a 4–20 mA analog output signal (to *Analog Output 1*):

- P2.3.2.1 = AnOUT:A.1
- P2.3.2.2 = 1 (DCCurrent±)
- P2.3.2.3 = 1.00 s
- P2.3.2.4 = 0 (Not inverted)
- P2.3.2.5 = 1 (4 mA)
- P2.3.2.6 = 40%

6.3.2.2 Analog Output 1

6.3.2.2.1 (ID 464) Analog Output 1 Signal Selection

Location in the menu: **P2.3.2.1**

Use this parameter to connect the analog output signal 1 to the selected analog output.

The signal selection is done with "Terminal to Function" (TTF) programming. See [6.11 "Terminal to Function" \(TTF\) Programming Principle](#).

6.3.2.2.2 (ID 307) Analog Output 1 Function

Location in the menu: **P2.3.2.2**

Use this parameter to select the function for the analog output 1 signal.

6.3.2.2.3 (ID 308) Analog Output 1 Filter Time

Location in the menu: **P2.3.2.3**

Use this parameter to set the filtering time of the analog output 1 signal.

Setting this parameter value to 0 deactivates filtering.

First order filtering is used for analog output signals.

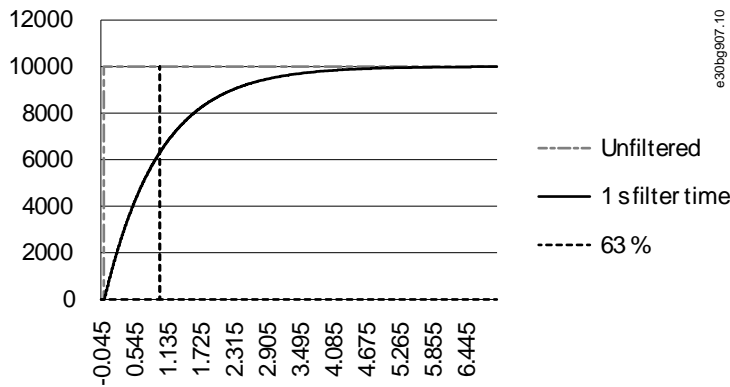

Illustration 12: Analog Output Filtering

6.3.2.2.4 (ID 309) Analog Output 1 Inversion

Location in the menu: **P2.3.2.4**

Use this parameter to invert the analog output 1 signal.

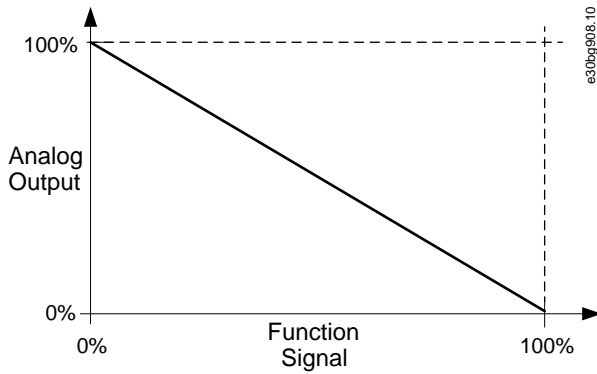

Illustration 13: Analog Output Inverting

6.3.2.2.5 (ID 310) Analog Output 1 Minimum

Location in the menu: **P2.3.2.5**

Use this parameter to set the minimum value of the analog output 1 signal.

The parameter defines the signal minimum to either 0 mA or 4 mA (living zero). Note the difference in analog output scaling in parameter *ID 311*.

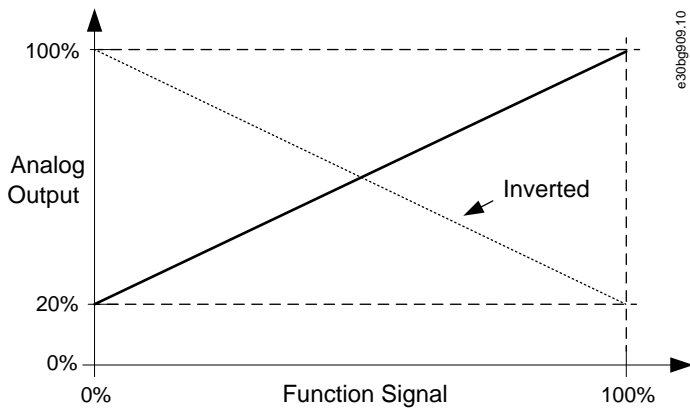

Illustration 14: Analog Output Minimum

6.3.2.2.6 (ID 311) Analog Output 1 Scale

Location in the menu: **P2.3.2.6**

Use this parameter to set the scaling factor for the analog 1 output.

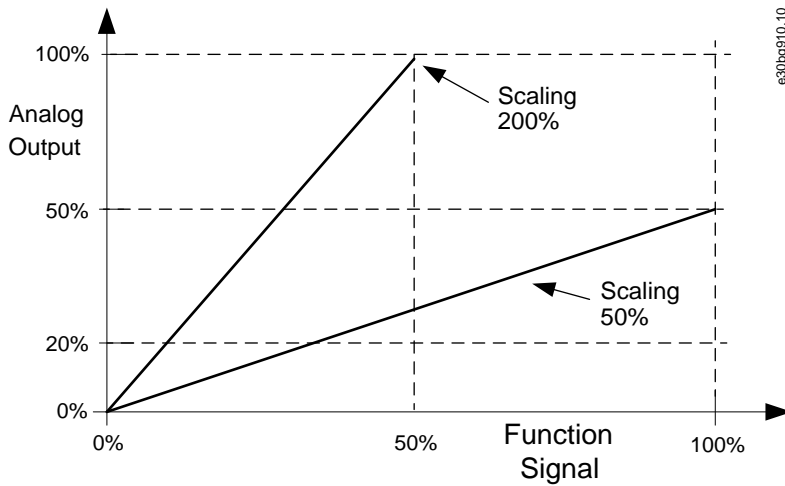

Illustration 15: Analog Output Scaling

6.3.2.2.7 (ID 375) Analog Output 1 Offset

Location in the menu: P2.3.2.7

Use this parameter to add offset to the analog output 1.

Add -100.0% to 100.0% to the analog output signal.

In the illustration, the 50% scaling signal has been given 20% offset and the 200% scaling has been given 50% offset.

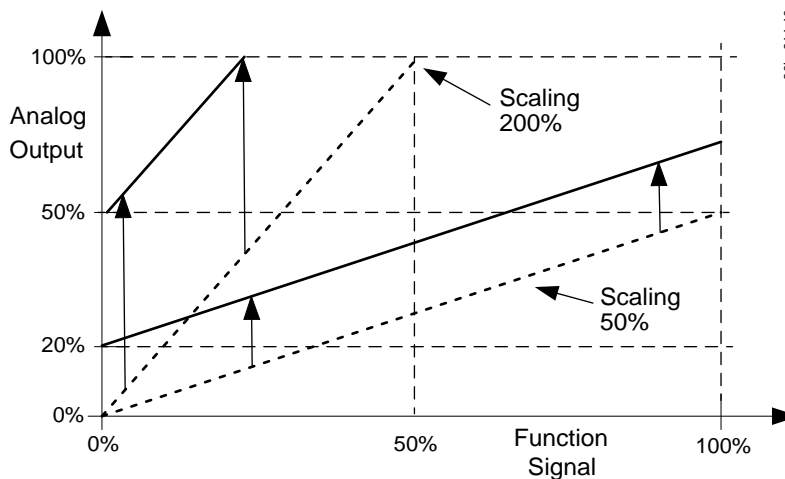

Illustration 16: Analog Output Offset Examples

6.3.2.3 Analog Output 2

6.3.2.3.1 (ID 471) Analog Output 2 Signal Selection

Location in the menu: P2.3.3.1

Use this parameter to connect the analog output signal 2 to the selected analog output.

The signal selection is done with "Terminal to Function" (TTF) programming. See [6.11 "Terminal to Function" \(TTF\) Programming Principle](#).

6.3.2.3.2 (ID 472) Analog Output 2 Function

Location in the menu: P2.3.3.2

Use this parameter to select the function for the analog output 2 signal.

- 0 = Not used (4 mA/2 V)
- 1 = DCCurrent± (-100%...+100% DC-link current)

6.3.2.3.3 (ID 473) Analog Output 2 Filter Time

Location in the menu: **P2.3.3.3**

Use this parameter to set the filtering time of the analog output 2 signal.

Setting this parameter value to 0 deactivates filtering.

First order filtering is used for analog output signals.

See [6.3.2.2.3 \(ID 308\) Analog Output 1 Filter Time](#).

6.3.2.3.4 (ID 474) Analog Output 2 Inversion

Location in the menu: **P2.3.3.4**

Use this parameter to invert the analog output 2 signal.

See [6.3.2.2.4 \(ID 309\) Analog Output 1 Inversion](#).

6.3.2.3.5 (ID 475) Analog Output 2 Minimum

Location in the menu: **P2.3.3.5**

Use this parameter to set the minimum value of the analog output 2 signal.

The parameter defines the signal minimum to either 0 mA or 4 mA (living zero). Note the difference in analog output scaling in parameter *ID 476*.

See [6.3.2.2.5 \(ID 310\) Analog Output 1 Minimum](#).

6.3.2.3.6 (ID 476) Analog Output 2 Scale

Location in the menu: **P2.3.3.6**

Use this parameter to set the scaling factor for the analog 2 output.

See [6.3.2.2.6 \(ID 311\) Analog Output 1 Scale](#).

6.3.2.3.7 (ID 477) Analog Output 2 Offset

Location in the menu: **P2.3.3.7**

Use this parameter to add offset to the analog output 2.

Add -100.0% to 100.0% to the analog output signal.

See [6.3.2.2.7 \(ID 375\) Analog Output 1 Offset](#).

6.3.2.4 Analog Output 3

6.3.2.4.1 (ID 478) Analog Output 3 Signal Selection

Location in the menu: **P2.3.4.1**

Use this parameter to connect the analog output signal 3 to the selected analog output.

The signal selection is done with "Terminal to Function" (TTF) programming. See [6.11 "Terminal to Function" \(TTF\) Programming Principle](#).

6.3.2.4.2 (ID 479) Analog Output 3 Function

Location in the menu: **P2.3.4.2**

Use this parameter to select the function for the analog output 3 signal.

- 0 = Not used (4 mA/2 V)
- 1 = DCCurrent± (-100%...+100% DC-link current)

6.3.2.4.3 (ID 480) Analog Output 3 Filter Time

Location in the menu: **P2.3.4.3**

Use this parameter to set the filtering time of the analog output 3 signal.

Setting this parameter value to 0 deactivates filtering.

First order filtering is used for analog output signals.

See [6.3.2.2.3 \(ID 308\) Analog Output 1 Filter Time](#).

6.3.2.4.4 (ID 481) Analog Output 3 Inversion

Location in the menu: **P2.3.4.4**

Use this parameter to invert the analog output 3 signal.

See [6.3.2.2.4 \(ID 309\) Analog Output 1 Inversion](#).

6.3.2.4.5 (ID 482) Analog Output 3 Minimum

Location in the menu: **P2.3.4.5**

Use this parameter to set the minimum value of the analog output 3 signal.

The parameter defines the signal minimum to either 0 mA or 4 mA (living zero).

Note the difference in analog output scaling in parameter *ID 483*.

See [6.3.2.2.5 \(ID 310\) Analog Output 1 Minimum](#).

6.3.2.4.6 (ID 483) Analog Output 3 Scale

Location in the menu: **P2.3.4.6**

Use this parameter to set the scaling factor for the analog 3 output.

See [6.3.2.2.6 \(ID 311\) Analog Output 1 Scale](#).

6.3.2.4.7 (ID 484) Analog Output 3 Offset

Location in the menu: **P2.3.4.7**

Use this parameter to add offset to the analog output 3.

Add -100.0% to 100.0% to the analog output signal.

See [6.3.2.2.7 \(ID 375\) Analog Output 1 Offset](#).

6.3.3 Supervision Limit

6.3.3.1 (ID 1862) Switch Lock Current Limit

Location in the menu: **P2.3.5.1**

Use this parameter to set the supervision limit for the parameter *P2.3.1.13 Switch Lock* (ID 1527).

6.4 Limit Settings

6.4.1 Current Limit

6.4.1.1 (ID 1500) U Phase Trip Limit

Location in the menu: **P2.4.1.1**

Use this parameter to set the trip limit for the rapid current cut-off in the U phase. The tripping limit is set in % of the nominal current. The default setting in the peer-to-peer topology is 150%. The trip triggers fault F63.

- Nominal current in air-cooled inverter units = I_L
- Nominal current in liquid-cooled inverter units = I_{TH}

The system software handles the current cut-off functionality. The functionality depends on a sufficient inductance in the output filter. Standard dU/dt filters do not have enough inductance to ensure an exact tripping level.

6.4.1.2 (ID 1501) V Phase Trip Limit

Location in the menu: **P2.4.1.2**

Use this parameter to set the trip limit for the rapid current cut-off in the V phase. The tripping limit is set in % of the nominal current. The default setting in the peer-to-peer topology is 150%. The trip triggers fault F64.

- Nominal current in air-cooled inverter units = I_L
- Nominal current in liquid-cooled inverter units = I_{TH}

The system software handles the current cut-off functionality. The functionality depends on a sufficient inductance in the output filter. Standard dU/dt filters do not have enough inductance to ensure an exact tripping level.

6.4.1.3 (ID 1502) W Phase Trip Limit

Location in the menu: **P2.4.1.3**

Use this parameter to set the trip limit for the rapid current cut-off in the W phase. The tripping limit is set in % of the nominal current. The default setting in the peer-to-peer topology is 150%. The trip triggers fault F65.

- Nominal current in air-cooled inverter units = I_L
- Nominal current in liquid-cooled inverter units = I_{TH}

The system software handles the current cut-off functionality. The functionality depends on a sufficient inductance in the output filter. Standard dU/dt filters do not have enough inductance to ensure an exact tripping level.

6.4.1.4 (ID 1859) Fast Reclosing

Location in the menu: **P2.4.1.4**

Use this parameter to enable the *Fast reclosing* function.

The fast reclosing function is not used in the VACON® DCGuard® peer-to-peer topology.

6.4.1.5 (ID 673) Prediction Gain

Location in the menu: **P2.4.1.5**

Use this parameter to set the gain for the short circuit current detection.

6.4.1.6 (ID 1874) SW Trip Response

Location in the menu: **P2.4.1.6**

Use this parameter to set the *SW trip response* when the current is above the limit set for the rapid current cut-off (see ID 1500, ID 1501, and ID 1502).

Table 48: Selections for Parameter ID 1874

Selection number	Selection name
0	No action
1	Warning information
2	Fault
3	Warning, keep control word

For selection 2, there is a separate fault code for each phase:

- F63, U phase overcurrent
- F64, V phase overcurrent
- F65, W phase overcurrent

6.5 Drive Control Parameters

6.5.1 (ID 601) Switching Frequency

Location in the menu: **P2.5.1**

Use this parameter to set the *Switching frequency* for the controlled ramp up of the voltage in the DC cables out of the DCGuard. The *Switching frequency* is used only during the charging procedure. The default setting is 5.0 kHz.

6.5.2 (ID 606) Pulse Ratio

Location in the menu: **P2.5.2**

Use this parameter to set the minimum *Pulse ratio* for charging the DC link of the DCGuard peer-to-peer connection. The charging is started with a certain minimum voltage, not from zero voltage.

6.5.3 (ID 1541) Voltage Rise Time

Location in the menu: **P2.5.3**

Use this parameter to set the *Voltage rise time* to full DC-link voltage in the bus tie cables. The recommended *Voltage rise time* is 200–600 ms.

6.5.4 (ID 1084) Control Options 1

Location in the menu: **P2.5.4**

This parameter is reserved for future use.

6.5.5 (ID 1798) Control Options 2

Location in the menu: **P2.5.5**

This parameter is reserved for future use.

6.5.6 (ID 1508) DCG Control Word

Location in the menu: **P2.5.6**

Use this parameter to set the bit-coded control commands from the DCGuard application software to the system software.

Table 49: DCG Control Word Description

Bit	Function	Notes
b6	Disable SD start	Reserved for testing purposes
b7	Disable ramp	Reserved for testing purposes
b8	Disable sequence charge	Reserved for testing purposes
b10		
b11		
b12		
b13		
b14		
b15		

6.5.7 (ID 1800) Start Delay

Location in the menu: **P2.5.7**

Use this parameter to set the time delay for the internal start command.

When several units receive the start command at the same time, the delay can be used to start the drives at different times.

6.5.8 (ID 1424) Restart Delay

Location in the menu: **P2.5.8**

Use this parameter to set the time delay within which the drive cannot be restarted after the drive has stopped.

6.5.9 Identification

6.5.9.1 (ID 668) IU Offset

Location in the menu: **P2.5.6.1**

Use this parameter to set the offset value for the phase current measurement.

6.5.9.2 (ID 669) IV Offset

Use this parameter to set the offset value for the phase current measurement.

6.5.9.3 (ID 670) IW Offset

Use this parameter to set the offset value for the phase current measurement.

6.6 Master/Follower

6.6.1 (ID 1324) Master/Follower Mode

Location in the menu: **P2.6.1**

This parameter is under development.

6.7 Fieldbus Parameters

6.7.1 (ID 1853) Fieldbus Actual Selection

Location in the menu: **P2.7.1**

Use this parameter to select the signal ID that is used as the actual monitoring value from the drive.

6.7.2 (ID 897) General Status Word ID

Location in the menu: **P2.7.2**

Use this parameter to select which data are sent in the Fieldbus General Status Word. See the user manual for the used fieldbus for details and availability.

6.7.3 (ID 852) Fieldbus Process Data Out 1 Selection

Location in the menu: **P2.7.3**

Use this parameter to select the data that is sent to the fieldbus with the ID number of the parameter or monitor value. To monitor an item, enter the ID number of the item as the value of this parameter.

6.7.4 (ID 853) Fieldbus Process Data Out 2 Selection

Location in the menu: **P2.7.4**

Use this parameter to select the data that is sent to the fieldbus with the ID number of the parameter or monitor value. To monitor an item, enter the ID number of the item as the value of this parameter.

6.7.5 (ID 854) Fieldbus Process Data Out 3 Selection

Location in the menu: **P2.7.5**

Use this parameter to select the data that is sent to the fieldbus with the ID number of the parameter or monitor value. To monitor an item, enter the ID number of the item as the value of this parameter.

6.7.6 (ID 855) Fieldbus Process Data Out 4 Selection

Location in the menu: **P2.7.6**

Use this parameter to select the data that is sent to the fieldbus with the ID number of the parameter or monitor value. To monitor an item, enter the ID number of the item as the value of this parameter.

6.7.7 (ID 856) Fieldbus Process Data Out 5 Selection

Location in the menu: **P2.7.7**

Use this parameter to select the data that is sent to the fieldbus with the ID number of the parameter or monitor value. To monitor an item, enter the ID number of the item as the value of this parameter.

6.7.8 (ID 857) Fieldbus Process Data Out 6 Selection

Location in the menu: **P2.7.8**

Use this parameter to select the data that is sent to the fieldbus with the ID number of the parameter or monitor value. To monitor an item, enter the ID number of the item as the value of this parameter.

6.7.9 (ID 858) Fieldbus Process Data Out 7 Selection

Location in the menu: **P2.7.9**

Use this parameter to select the data that is sent to the fieldbus with the ID number of the parameter or monitor value. To monitor an item, enter the ID number of the item as the value of this parameter.

6.7.10 (ID 859) Fieldbus Process Data Out 8 Selection

Location in the menu: **P2.7.10**

Use this parameter to select the data that is sent to the fieldbus with the ID number of the parameter or monitor value.
To monitor an item, enter the ID number of the item as the value of this parameter.

6.7.11 (ID 876) Fieldbus Process Data In 1 Selection

Location in the menu: **P2.7.11**

Use this parameter to select a parameter or monitoring value to be controlled from the fieldbus.
To control an item, enter the ID number of the item as the value of this parameter.
The monitoring signals that can be controlled from the fieldbus are shadowed.

6.7.12 (ID 877) Fieldbus Process Data In 2 Selection

Location in the menu: **P2.7.12**

Use this parameter to select a parameter or monitoring value to be controlled from the fieldbus.
To control an item, enter the ID number of the item as the value of this parameter.
The monitoring signals that can be controlled from the fieldbus are shadowed.

6.7.13 (ID 878) Fieldbus Process Data In 3 Selection

Location in the menu: **P2.7.13**

Use this parameter to select a parameter or monitoring value to be controlled from the fieldbus.
To control an item, enter the ID number of the item as the value of this parameter.
The monitoring signals that can be controlled from the fieldbus are shadowed.

6.7.14 (ID 879) Fieldbus Process Data In 4 Selection

Location in the menu: **P2.7.14**

Use this parameter to select a parameter or monitoring value to be controlled from the fieldbus.
To control an item, enter the ID number of the item as the value of this parameter.
The monitoring signals that can be controlled from the fieldbus are shadowed.

6.7.15 (ID 880) Fieldbus Process Data In 5 Selection

Location in the menu: **P2.7.15**

Use this parameter to select a parameter or monitoring value to be controlled from the fieldbus.
To control an item, enter the ID number of the item as the value of this parameter.
The monitoring signals that can be controlled from the fieldbus are shadowed.

6.7.16 (ID 881) Fieldbus Process Data In 6 Selection

Location in the menu: **P2.7.16**

Use this parameter to select a parameter or monitoring value to be controlled from the fieldbus.
To control an item, enter the ID number of the item as the value of this parameter.
The monitoring signals that can be controlled from the fieldbus are shadowed.

6.7.17 (ID 882) Fieldbus Process Data In 7 Selection

Location in the menu: **P2.7.17**

Use this parameter to select a parameter or monitoring value to be controlled from the fieldbus.
To control an item, enter the ID number of the item as the value of this parameter.
The monitoring signals that can be controlled from the fieldbus are shadowed.

6.7.18 (ID 883) Fieldbus Process Data In 8 Selection

Location in the menu: **P2.7.18**

Use this parameter to select a parameter or monitoring value to be controlled from the fieldbus.
To control an item, enter the ID number of the item as the value of this parameter.
The monitoring signals that can be controlled from the fieldbus are shadowed.

6.7.19 (ID 896) State Machine

Location in the menu: **P2.7.19**

Use this parameter to select the control profile (*State machine*) for the fieldbus control.

Table 50: Selections for Parameter ID 896

Selection number	Selection name	Description
0	Basic	This mode makes the fieldbus control behave as explained in the used fieldbus option board manual.
1	Standard	A simple control word is used in modes where the control word from the fieldbus is used as such. For some fieldbus boards, this mode requires a bypass operation.
2	DCGuard Profile 1	Rising pulse and stop commands.

6.8 Protections

6.8.1 (ID 1857) Reset Data Logger

Location in the menu: **P2.8.8**

Use this parameter to reset the data logger to its default settings. If the settings are changed, it is recommended to reset the settings after initial commissioning.

6.8.2 (ID 1569) Fault Simulation

Location in the menu: **P2.8.9**

Use this parameter to simulate different faults without actually making, for example, an overcurrent situation. In the point of view of the drive interface, the operation is identical to an actual fault situation.

Table 51: Selections for Parameter ID 1569

Selection	Description
B00 (+1)	Simulates overcurrent fault (F1)
B01 (+2)	Simulates overvoltage fault (F2)
B02 (+4)	Simulates undervoltage fault (F9)
B03 (+8)	Reserved
B04 (+16)	Simulates earth fault (F3)
B05 (+32)	Reserved
B06 (+64)	Reserved
B07 (+128)	Simulates overtemperature alarm (F14)
B08 (+256)	Simulates overtemperature fault (F14) The alarm bit must be active so that the fault comes in the simulation. If the fault bit is left active, the drive goes to a fault state at the alarm limit when the drive temperature rises to the alarm level.

6.8.3 (ID 1086) Disable Stop Lock

Location in the menu: **P2.8.10**

Use this parameter to disable the stop lock and enable the setting of parameters when the drive is in RUN state. This parameter is only available for internal use by Danfoss personnel.

6.8.4 General

6.8.4.1 (ID 1333) Earth Fault Current Limit

Location in the menu: **P2.8.1.1**

Use this parameter to select the maximum level for the earth current in % of the unit nominal current.

The earth fault protection ensures that the sum of the outgoing phase currents is zero. The overcurrent protection is always working and protects the DCGuard from earth faults with high currents. The functionality is based on the sum of all three output phases.

6.8.4.2 (ID 1858) Vdc Trip Limit

Location in the menu: **P2.8.1.2**

Use this parameter to select the trip limit for the software DC-link voltage trip.

6.8.4.3 (ID 733) Fieldbus Fault Slot D Response

Location in the menu: **P2.8.1.3**

If the active control place is fieldbus, use this parameter to select the response for a fieldbus fault.

Table 52: Selections for Parameter ID 733

Selection number	Selection name
0	No response
1	Warning
2	Fault
3	Warning, keep control word

6.8.4.4 (ID 1329) Keypad/PC Fault Mode

Location in the menu: **P2.8.1.4**

If the active control place is keypad, use this parameter to select the response for the keypad communication fault.

If the active control place is PC (NCDrive), use this parameter to select the response for the PC (NCDrive) communication fault.

If the active control place is keypad, make sure that there is a possibility to stop the DCGuard also in case the keypad is removed from the drive. In case 0/*No response* or 1/*Warning* is selected, it must be ensured on system level that there is the possibility for local control. This can be done, for example, by forcing to I/O or fieldbus control by a digital input.

Table 53: Selections for Parameter ID 1329

Selection number	Selection name
0	No response ⁽¹⁾
1	Warning ⁽¹⁾
2	Fault
3	Warning, keep control word

¹ If selected, it must be ensured on system level that there is the possibility for local control.

6.8.5 Over Load Protection

6.8.5.1 Function Description

The over load protection function protects the DC cables. The function is based on an internal counter. The counter value is increased when the input current is above the *Minimum input* level and decreased when below the value. The increase or decrease occurs every 10 ms.

The over load trip is done when the over load counter value is over 10000.

The parameter *Maximum step* defines the increase when the input reaches the maximum defined input level (*Maximum input*). The minimum and maximum input points also define the slope for the function. For example, if the input current is in the middle of the minimum and maximum input values, the counter increases by half of the value set with *Maximum step* parameter.

The over load counter calculation is done individually for each phase.

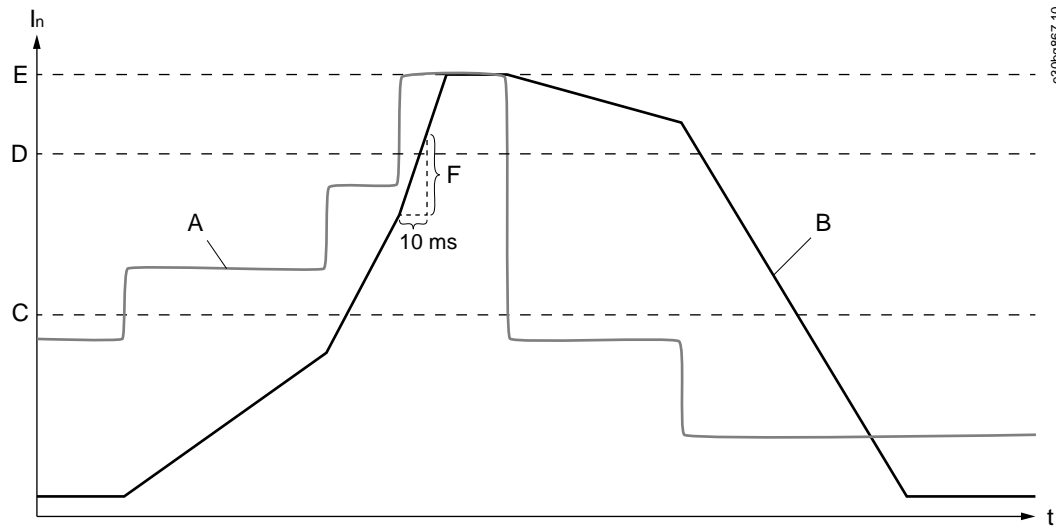

Illustration 17: Example of the Internal Counter Value as a Function of the Motor Current

A	Motor current in % of the nominal current rating	D	Maximum input
B	Over load counter value	E	Over load trip level
C	Minimum input	F	Maximum step

Example

Parameter example for tripping at 120% after 20 s:

- P2.8.X.1, X Overload Response = 2
- P2.8.X.2, Minimum Input = 101%
- P2.8.X.3, Maximum Input = 120%
- P2.8.X.4, Maximum Step = 5

Tripping time = $10000 / (P2.8.X.4 \times 100) = 10000 / (5 \times 100) = 20 \text{ s}$

6.8.5.2 U Phase Over Load Protection

6.8.5.2.1 (ID 1524) U Over Load Response

Location in the menu: P2.8.2.1

Use this parameter to set the trip response when the over load protection counter is above the tripping limit in phase U.

- 0 = No Action
- 1 = Warning information
- 2 = Fault

Selection 2 gives the fault code F83, U phase over load.

6.8.5.2.2 (ID 1504) Minimum Input U

Location in the menu: P2.8.2.2

Use this parameter to set the U phase current level in % of the rated current when the over load counter starts to increase.

6.8.5.2.3 (ID 1505) Maximum Input U

Location in the menu: P2.8.2.3

Use this parameter to set the input value level for phase U where the over load counter is increased with the maximum step defined by parameter ID 1506.

6.8.5.2.4 (ID 1506) Maximum Step U

Location in the menu: **P2.8.2.4**

Use this parameter to set the step in the phase U over load counter when the input value is at the maximum input level defined by parameter ID 1505.

6.8.5.3 V Phase Over Load Protection

6.8.5.3.1 (ID 1525) V Over Load Response

Location in the menu: **P2.8.3.1**

Use this parameter to set the trip response when the over load protection counter is above the tripping limit in phase V.

- 0 = No Action
- 1 = Warning information
- 2 = Fault

Selection 2 gives the fault code F84, V phase over load.

6.8.5.3.2 (ID 1531) Minimum Input V

Location in the menu: **P2.8.3.2**

Use this parameter to set the V phase current level in % of the rated current when the over load counter starts to increase.

6.8.5.3.3 (ID 1532) Maximum Input V

Location in the menu: **P2.8.3.3**

Use this parameter to set the input value level for phase V where the over load counter is increased with the maximum step defined by parameter ID 1533.

6.8.5.3.4 (ID 1533) Maximum Step V

Location in the menu: **P2.8.3.4**

Use this parameter to set the step in the phase V over load counter when the input value is at the maximum input level defined by parameter ID 1532.

6.8.5.4 W Phase Over Load Protection

6.8.5.4.1 (ID 1526) W Over Load Response

Location in the menu: **P2.8.4.1**

Use this parameter to set the trip response when the over load protection counter is above the tripping limit in phase W.

- 0 = No Action
- 1 = Warning information
- 2 = Fault

Selection 2 gives the fault code F85, W phase over load.

6.8.5.4.2 (ID 1534) Minimum Input W

Location in the menu: **P2.8.4.2**

Use this parameter to set the W phase current level in % of the rated current when the over load counter starts to increase.

6.8.5.4.3 (ID 1535) Maximum Input W

Location in the menu: **P2.8.4.3**

Use this parameter to set the input value level for phase W where the over load counter is increased with the maximum step defined by parameter ID 1536.

6.8.5.4.4 (ID 1536) Maximum Step W

Location in the menu: **P2.8.4.4**

Use this parameter to set the step in the phase W over load counter when the input value is at the maximum input level defined by parameter ID 1535.

6.8.6 U Phase Current Protection

6.8.6.1 (ID 1550) U High Current Response

Location in the menu: **P2.8.5.1**

Use this parameter to set the trip response when the current is above the set limit in phase U for the time set for the high current cut-off.

- 0 = No Warning, no action
- 1 = Warning information, no action
- 2 = Warning, the phase with overcurrent is disabled
- 3 = Fault, the drive is stopped

Selection 3 gives the fault code F86, U high current.

6.8.6.2 (ID 1551) U Trip Limit

Location in the menu: **P2.8.5.2**

Use this parameter to set the trip limit for the high current cut-off in the U phase. The tripping limit is set in % of the nominal current. The trip triggers fault F86.

- Nominal current in air-cooled inverter units = I_L
- Nominal current in liquid-cooled inverter units = I_{TH}

The application software handles the current cut-off functionality at the 10 ms level.

6.8.6.3 (ID 1552) U Trip Delay

Location in the menu: **P2.8.5.3**

Use this parameter to set the trip delay for the high current cut-off in the U phase.

6.8.7 V Phase Current Protection

6.8.7.1 (ID 1553) V High Current Response

Location in the menu: **P2.8.6.1**

Use this parameter to set the trip response when the current is above the set limit in phase V for the time set for the high current cut-off.

- 0 = No Warning, no action
- 1 = Warning information, no action
- 2 = Warning, the phase with overcurrent is disabled
- 3 = Fault, the drive is stopped

Selection 3 gives the fault code F87, V high current.

6.8.7.2 (ID 1554) V Trip Limit

Location in the menu: **P2.8.6.2**

Use this parameter to set the trip limit for the high current cut-off in the V phase. The tripping limit is set in % of the nominal current. The trip triggers fault F87.

- Nominal current in air-cooled inverter units = I_L
- Nominal current in liquid-cooled inverter units = I_{TH}

The application software handles the current cut-off functionality at the 10 ms level.

6.8.7.3 (ID 1555) V Trip Delay

Location in the menu: **P2.8.6.3**

Use this parameter to set the trip delay for the high current cut-off in the V phase.

6.8.8 W Phase Current Protection

6.8.8.1 (ID 1556) W High Current Response

Location in the menu: **P2.8.7.1**

Use this parameter to set the trip response when the current is above the set limit in phase W for the time set for the high current cut-off.

- 0 = No Warning, no action
- 1 = Warning information, no action
- 2 = Warning, the phase with overcurrent is disabled
- 3 = Fault, the drive is stopped

Selection 3 gives the fault code F88, W high current.

6.8.8.2 (ID 1558) W Trip Limit

Location in the menu: **P2.8.7.2**

Use this parameter to set the trip limit for the high current cut-off in the W phase. The tripping limit is set in % of the nominal current. The trip triggers fault F88.

- Nominal current in air-cooled inverter units = I_L
- Nominal current in liquid-cooled inverter units = I_{TH}

The application software handles the current cut-off functionality at the 10 ms level.

6.8.8.3 (ID 1559) W Trip Delay

Location in the menu: **P2.8.7.3**

Use this parameter to set the trip delay for the high current cut-off in the W phase.

6.9 ID Functions

6.9.1 Function Description

The ID functions use the parameter ID number to control and monitor the signal.

6.9.2 Value Control

6.9.2.1 Value Control Parameters

The value control parameters are used to control an input signal parameter.

6.9.2.2 (ID 1590) Control Mode

Location in the menu: **P2.9.1.1**

Use this parameter to define how the value control output behaves.

0 = SR ABS

Absolute input value is used to make a step change in the output between On and Off values.

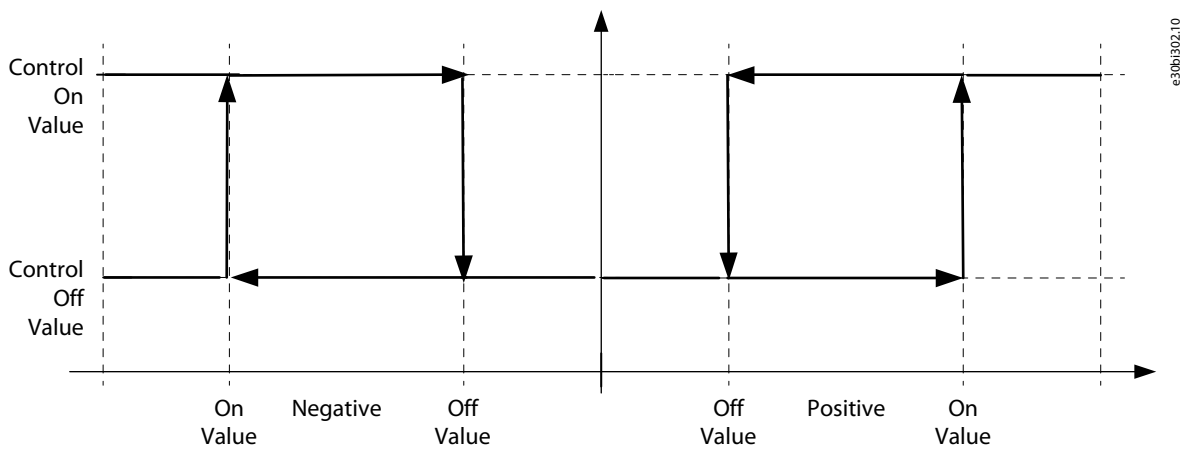

Illustration 18: Step Response to Absolute Input Value

1 = Scale ABS

Absolute input value is scaled linearly between On and Off values.

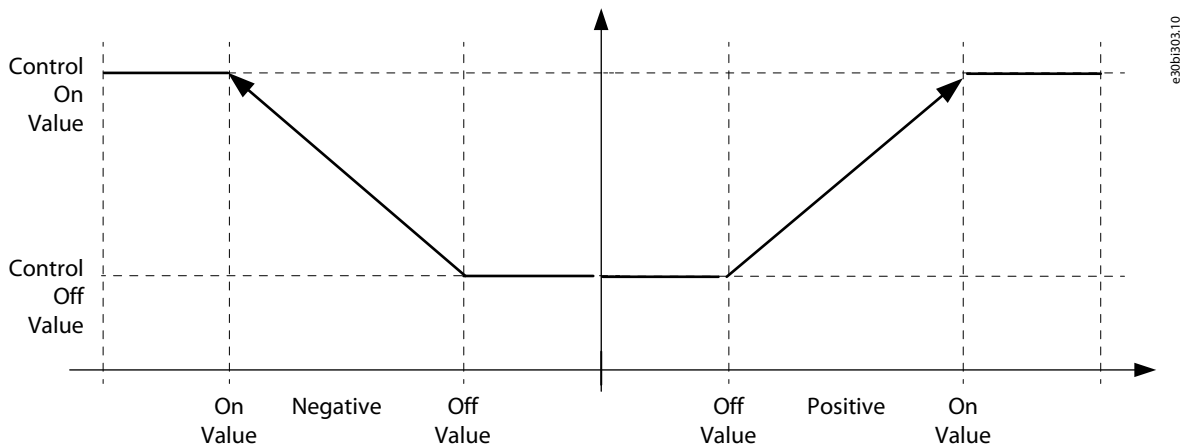

Illustration 19: Scaling of Absolute Input Value

2 = Scale ABS Inverted

Inverted absolute value is scaled linearly between On and Off values.

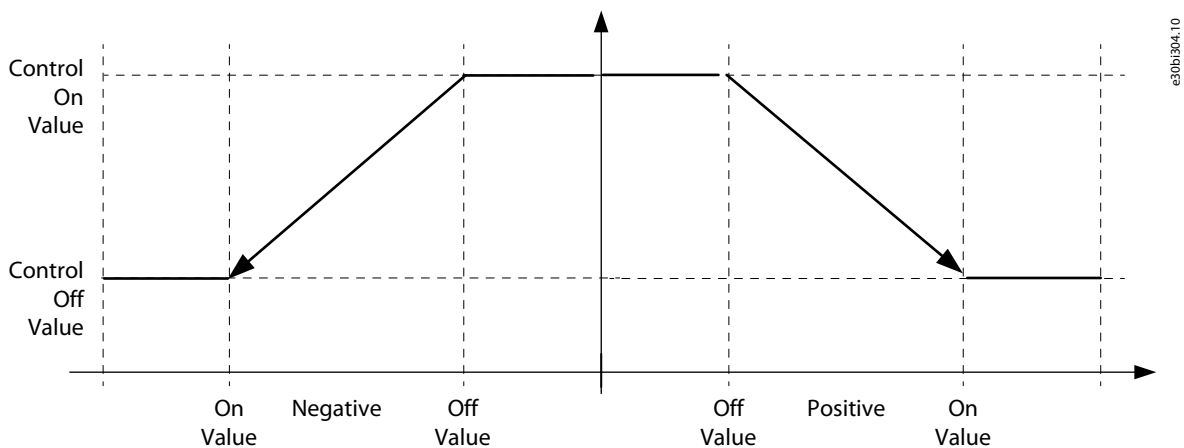

Illustration 20: Scaling of Inverted Absolute Input Value

3 = SR

Input value is used to make a step change in the output between On and Off values.

4 = Scale

Input value is scaled linearly between On and Off values.

5 = Scale Inverted

Inverted value is scaled linearly between On and Off values

6 = XY Control

Use the X and Y Value parameters to create a custom curve.

6.9.2.3 (ID 1580) Control Input Signal ID

Location in the menu: **P2.9.1.2**

Use this parameter to select which signal is used to control the selected parameter.

6.9.2.4 (ID 1581) Control Off Limit

Location in the menu: **P2.9.1.3**

Use this parameter to select the limit when the selected parameter value is forced to Off value.

6.9.2.5 (ID 1582) Control On Limit

Location in the menu: **P2.9.1.4**

Use this parameter to select the limit when the selected parameter value is forced to On value.

6.9.2.6 (ID 1583) Control Off Value

Location in the menu: **P2.9.1.5**

Use this parameter to select the value that is used when the used input signal is below Off limit.

6.9.2.7 (ID 1584) Control On Value

Location in the menu: **P2.9.1.6**

Use this parameter to select the value that is used when the used input signal is above On limit.

6.9.2.8 (ID 1585) Control Output Signal ID

Location in the menu: **P2.9.1.7**

Use this parameter to select which parameter is forced to On and Off values when the selected input signal exceeds the set limits.

6.9.2.9 (ID 1721) Control Signal Filtering TC

Location in the menu: **P2.9.1.8**

Use this parameter to filter the scaling function output. Used, for example, when unfiltered torque is used to control a parameter that needs stabilization.

6.9.2.10 XY Control Parameters

With the XY Control function, it is possible to make a custom control curve. For example, by selecting DC-link voltage as the input signal, the selected points can control the current reference based on the DC-link voltage level.

- X-values are input values.
- Y-values are output values.

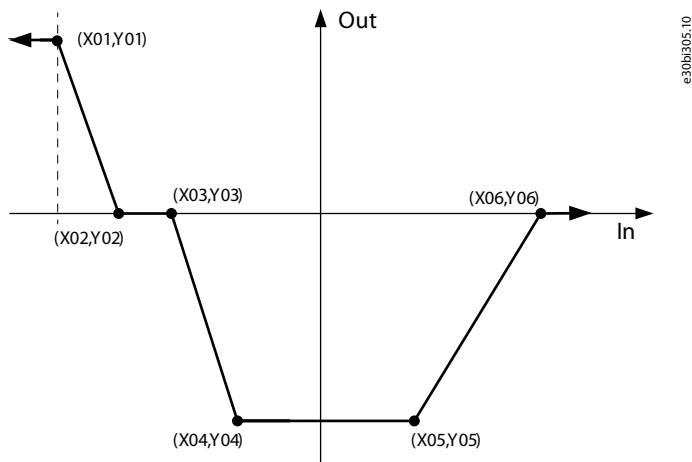

Illustration 21: XY Control Curve Example

6.9.2.11 (ID 1626) X Value 01

Location in the menu: **P2.9.1.9**

Use this parameter to set the X Value 01 input value for XY Control. See [6.9.2.10 XY Control Parameters](#).

6.9.2.12 (ID 2001) Y Value 01

Location in the menu: **P2.9.1.10**

Use this parameter to set the Y Value 01 output value for XY Control. See [6.9.2.10 XY Control Parameters](#).

6.9.2.13 (ID 1627) X Value 02

Location in the menu: **P2.9.1.11**

Use this parameter to set the X Value 02 input value for XY Control. See [6.9.2.10 XY Control Parameters](#).

6.9.2.14 (ID 2002) Y Value 02

Location in the menu: **P2.9.1.12**

Use this parameter to set the Y Value 02 output value for XY Control. See [6.9.2.10 XY Control Parameters](#).

6.9.2.15 (ID 1628) X Value 03

Location in the menu: **P2.9.1.13**

Use this parameter to set the X Value 03 input value for XY Control. See [6.9.2.10 XY Control Parameters](#).

6.9.2.16 (ID 2003) Y Value 03

Location in the menu: **P2.9.1.14**

Use this parameter to set the Y Value 03 output value for XY Control. See [6.9.2.10 XY Control Parameters](#).

6.9.2.17 (ID 1629) X Value 04

Location in the menu: **P2.9.1.15**

Use this parameter to set the X Value 04 input value for XY Control. See [6.9.2.10 XY Control Parameters](#).

6.9.2.18 (ID 2004) Y Value 04

Location in the menu: **P2.9.1.16**

Use this parameter to set the Y Value 04 output value for XY Control. See [6.9.2.10 XY Control Parameters](#).

6.9.2.19 (ID 1630) X Value 05

Location in the menu: **P2.9.1.17**

Use this parameter to set the X Value 05 input value for XY Control. See [6.9.2.10 XY Control Parameters](#).

6.9.2.20 (ID 2005) Y Value 05

Location in the menu: **P2.9.1.18**

Use this parameter to set the Y Value 05 output value for XY Control. See [6.9.2.10 XY Control Parameters](#).

6.9.2.21 (ID 1631) X Value 06

Location in the menu: **P2.9.1.19**

Use this parameter to set the X Value 06 input value for XY Control. See [6.9.2.10 XY Control Parameters](#).

6.9.2.22 (ID 2006) Y Value 06

Location in the menu: **P2.9.1.20**

Use this parameter to set the Y Value 06 output value for XY Control. See [6.9.2.10 XY Control Parameters](#).

6.9.3 DIN ID Control Parameters

This function is used to control any parameter between two different values with a digital input. Different values are given for DI 'low' and DI 'high'.

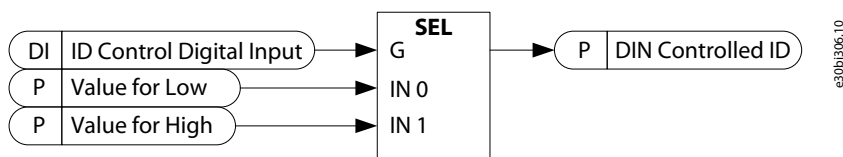

Illustration 22: DIN ID Control Logic Diagram

6.9.4 DIN ID Control 1

6.9.4.1 (ID 1570) ID Control Digital Input

Location in the menu: **P2.9.2.1**

Use this parameter to select the digital input to be used for controlling the parameters selected by:

- ID 1571, DIN Controlled ID
- ID 1572, Value for Low digital input (FALSE)
- ID 1573, Value for High digital input (TRUE)

6.9.4.2 (ID 1571) DIN Controlled ID

Location in the menu: **P2.9.2.2**

Use this parameter to select the parameter ID controlled by ID Control Digital Input (ID1570).

6.9.4.3 (ID 1572) Value for Low digital input (FALSE)

Location in the menu: **P2.9.2.3**

Use this parameter to select the controlled parameter value when the digital input (ID 1570) is Low for the parameter selected by ID 1571. The function does not recognize decimals. For example, give 10.00 Hz as '1000'.

6.9.4.4 (ID 1573) Value for High digital input (TRUE)

Location in the menu: **P2.9.2.4**

Use this parameter to select the controlled parameter value when the digital input (ID 1570) is High for the parameter selected by ID 1571. The function does not recognize decimals. For example, give 10.00 Hz as '1000'.

6.9.5 DIN ID Control 2

6.9.5.1 (ID 1574) ID Control Digital Input

Location in the menu: **P2.9.3.1**

Use this parameter to select the digital input to be used for controlling the parameters selected by:

- ID 1575, DIN Controlled ID
- ID 1576, Value for Low digital input (FALSE)
- ID 1577, Value for High digital input (TRUE)

6.9.5.2 (ID 1575) DIN Controlled ID

Location in the menu: **P2.9.3.2**

Use this parameter to select the parameter ID controlled by ID Control Digital Input (ID1574).

6.9.5.3 (ID 1576) Value for Low digital input (FALSE)

Location in the menu: **P2.9.3.3**

Use this parameter to select the controlled parameter value when the digital input (ID 1574) is Low for the parameter selected by ID 1575. The function does not recognize decimals. For example, give 10.00 Hz as '1000'.

6.9.5.4 (ID 1577) Value for High digital input (TRUE)

Location in the menu: **P2.9.3.4**

Use this parameter to select the controlled parameter value when the digital input (ID 1574) is High for the parameter selected by ID 1575. The function does not recognize decimals. For example, give 10.00 Hz as '1000'.

6.9.6 DIN ID Control 3

6.9.6.1 (ID 1578) ID Control Digital Input

Location in the menu: **P2.9.4.1**

Use this parameter to select the digital input to be used for controlling the parameters selected by:

- ID 1579, DIN Controlled ID
- ID 1587, Value for Low digital input (FALSE)
- ID 1588, Value for High digital input (TRUE)

6.9.6.2 (ID 1579) DIN Controlled ID

Location in the menu: **P2.9.4.2**

Use this parameter to select the parameter ID controlled by ID Control Digital Input (ID1578).

6.9.6.3 (ID 1587) Value for Low digital input (FALSE)

Location in the menu: **P2.9.4.3**

Use this parameter to select the controlled parameter value when the digital input (ID 1578) is Low for the parameter selected by ID 1579. The function does not recognize decimals. For example, give 10.00 Hz as '1000'.

6.9.6.4 (ID 1588) Value for High digital input (TRUE)

Location in the menu: **P2.9.4.4**

Use this parameter to select the controlled parameter value when the digital input (ID 1578) is High for the parameter selected by ID 1579. The function does not recognize decimals. For example, give 10.00 Hz as '1000'.

6.10 Keypad Control

6.10.1 (ID 125) Control Place

Location in the menu: **P3.1**

Use this parameter to select the *Control place*.

Selection	Control place
0	PC control
1	I/O terminal
2	Keypad (default)

Selection	Control place
3	Fieldbus
4	SystemBus Master (not in use)

6.10.2 (ID 1995) License Key

Location in the menu: **P3.2**

Use this parameter to set the *License key* to activate DCGuard operation.

Enclosure size FR4 400 V can be operated without a *License key*.

6.10.3 (ID 1863) Enable Keypad Close

Location in the menu: **P3.3**

Use this parameter to enable or disable the [Start] button (close) on the keypad.

0 = Disabled (default)

- The green keypad [Start] button (close) is disabled when DCGuard is controlled from I/O or fieldbus.

1 = Enabled

- The green keypad [Start] button (close) is enabled when DCGuard is controlled from I/O or fieldbus.

6.10.4 (ID 1864) Enable Keypad Open

Location in the menu: **P3.4**

Use this parameter to enable or disable the [Stop] button (open) on the keypad.

0 = Disabled (default)

- The red keypad [Stop] button (open) is disabled when DCGuard is controlled from I/O or fieldbus.

1 = Enabled

- The red keypad [Stop] button (open) is enabled when DCGuard is controlled from I/O or fieldbus.

6.11 "Terminal to Function" (TTF) Programming Principle

The programming principle of the input and output signals in the VACON® NXP DCGuard™ application is different compared to the conventional method used in other VACON® NXP applications. In the conventional programming method, Function to Terminal Programming Method (FTT), a certain function is defined for a fixed input or output. The VACON® NXP DCGuard™ application, however, uses the Terminal to Function Programming method (TTF) in which the programming process is carried out the other way round: Functions appear as parameters which the operator defines a certain input/output for. See the warning in [6.11.2 Defining a Terminal for a Certain Function with VACON® NCDrive](#).

6.11.1 Defining an Input/Output for a Certain Function on Keypad

Connecting a certain input or output with a certain function (parameter) is done by giving the parameter an appropriate value. The value is formed of the Board slot on the VACON® NX control board (see the User Manual of the product) and the respective signal number.

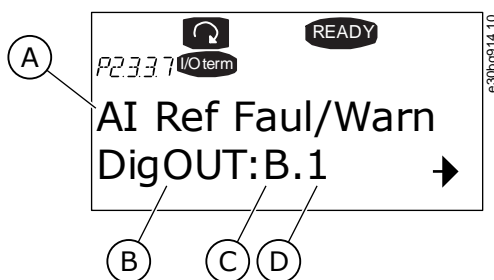
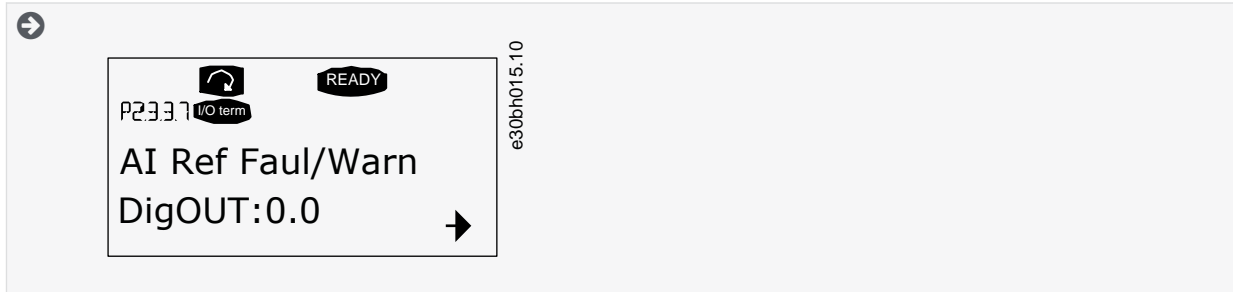

Illustration 23: Defining an Input/Output for a Certain Function on Keypad

A	Function name	C	Slot
B	Terminal type	D	Terminal number

Procedure

1. Find the parameter on the keypad. Press the Menu button right once to enter the edit mode. On the value line, see the terminal type on the left (DigIN, DigOUT, An.IN, An.OUT) and on the right, the present input/output the function is connected to (B.3, A.2, and so on), or if not connected, a value (0.#).



2. When the value is blinking, hold down the Browser button up or down to find the desired board slot and signal number. The program scrolls the board slots starting from 0 and proceeding from A to E and the I/O selection 1–10.

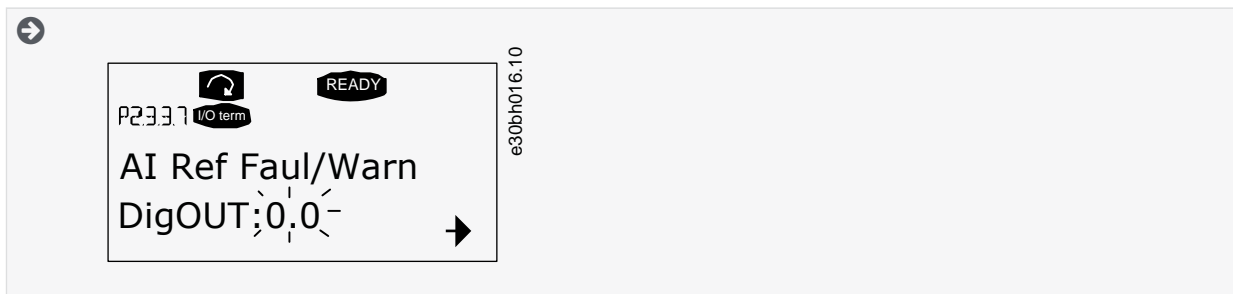

3. Once the desired value has been set, press the [enter] button once to confirm the change.

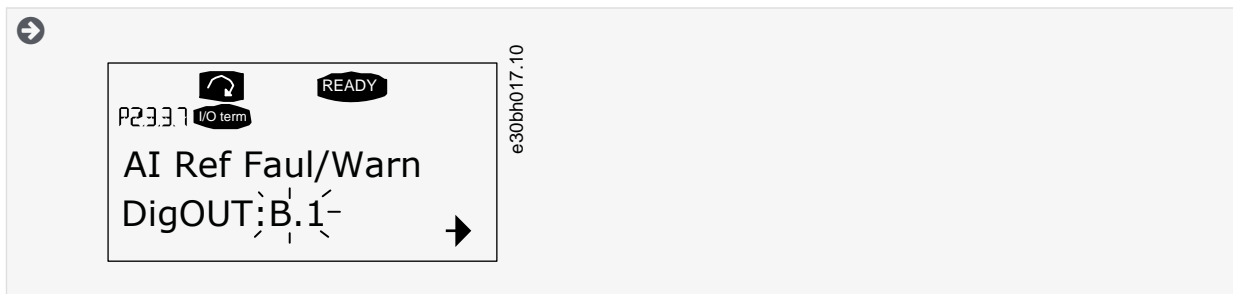

6.11.2 Defining a Terminal for a Certain Function with VACON® NCDriver

If using the VACON® NCDriver Programming Tool for parametrizing, the connection between the function and input/output must be established in the same way as with the control panel. Pick the address code from the drop-down menu in the *Value* column.

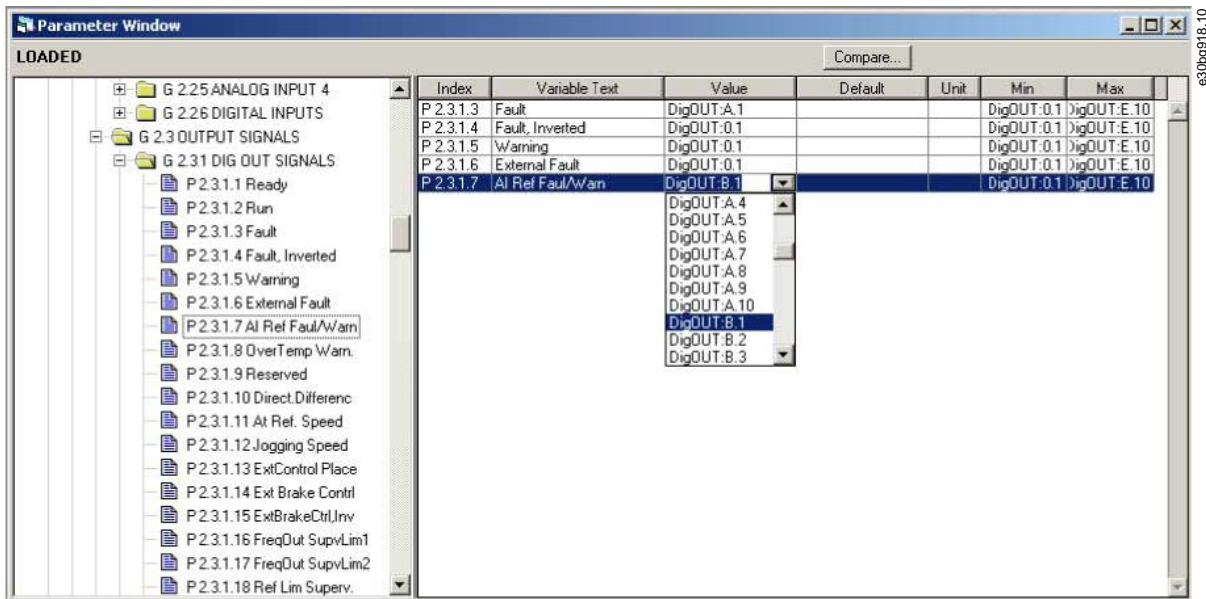

Illustration 24: Screenshot of the VACON® NCDrive Programming Tool; Entering the Address Code

CAUTION

FUNCTION OVERRUNS

Connecting two functions to one and same output in can cause function overruns.

- Do not to connect two functions to one and same output to avoid function overruns and to ensure flawless operation.

NOTICE

The inputs, unlike the outputs, cannot be changed in RUN state.

6.11.3 Defining Unused Inputs/Outputs

All unused inputs and outputs must be given the option slot value 0 and the value 1 also for the terminal number. The value 0.1 is also the default value for most of the functions. However, if, for example, the values of a digital input signal are used for testing purposes only, the option slot value can be set to 0 and the terminal number to any number between 2–10 to place the input to a TRUE state. In other words, the value 1 corresponds to 'open switch' and values 2–10 to 'closed switch'.

For analog inputs, giving the value 1 for the terminal number corresponds to 0% signal level, value 2 corresponds to 20%, value 3 to 30% and so on. Giving value 10 for the terminal number corresponds to 100% signal level.

6.12 Fieldbus Control In Detail

The fieldbus control and status words are bit-coded monitoring values.

The behavior of the fieldbus control word depends on the selected control profile. Do the selection with parameter *State machine* (ID 896). See [6.7.19 \(ID 896\) State Machine](#).

6.12.1 Fieldbus Control Word (Standard)

Table 54: Description of the Fieldbus Control Word with the Standard Profile

Bit	Signal	False	True
B00			
B01			
B02			
B03	Run (close)	Stop request:	Start request:

Bit	Signal	False	True
		The drive stops (DCGuard opens).	Start command to the drive. Rising edge needed for the start (DCGuard closes).
B04			
B05			
B06			
B07	Reset	No significance	Fault acknowledge: The group signal is acknowledged with a positive edge.
B08			
B09			
B10	PLC control	Disable fieldbus control: The drive stops.	Enable fieldbus control: If the control place is fieldbus, the start command is monitored from the fieldbus.
B11	Watchdog ⁽¹⁾	Fieldbus watchdog pulse low	Fieldbus watchdog pulse high
B12	Fieldbus digital input 2 ⁽²⁾		
B13	Fieldbus digital input 3 ⁽²⁾		
B14	Fieldbus digital input 4 ⁽²⁾		
B15			

¹ This pulse is used to monitor the communication between the PLC and the drive. If the pulse is missing, the drive goes to a fault state (Fieldbus communication fault). This bit is also connected to fieldbus status word B15.

² Not used

6.12.2 Fieldbus Control Word (DCGuard Profile 1)

Table 55: Description of the Fieldbus Control Word with the DCGuard Profile 1

Bit	Signal	False	True
B00			
B01	Stop (open)		Stop request: The drive stops (DCGuard opens).
B02			
B03	Run (close)		Start request: Start command to the drive. Rising edge needed for the start (DCGuard closes).
B04			
B05			
B06			
B07	Reset	No significance	Fault acknowledge: The group signal is acknowledged with a positive edge.

Bit	Signal	False	True
B08			
B09			
B10	PLC control	Disable fieldbus control: The drive stops.	Enable fieldbus control: If the control place is fieldbus, the start command is monitored from the fieldbus.
B11	Watchdog ⁽¹⁾	Fieldbus watchdog pulse low	Fieldbus watchdog pulse high
B12	Fieldbus digital input 2 ⁽²⁾		
B13	Fieldbus digital input 3 ⁽²⁾		
B14	Fieldbus digital input 4 ⁽²⁾		
B15			

¹ This pulse is used to monitor the communication between the PLC and the drive. If the pulse is missing, the drive goes to a fault state (Fieldbus communication fault). This bit is also connected to fieldbus status word B15.

² Not used

6.12.3 Fieldbus Status Word

Table 56: Description of the Fieldbus Status Word

Bit	Signal	False	True
B00	Ready on	Drive not ready to switch on Fault active DI: Run enable low	Drive ready to start charging No faults DI: Run enabled
B01	Ready run	Drive not ready to run (DCGuard not ready to close) CW.B0 = FALSE DC is not ready	Drive ready and main contactor is ON (DCGuard is ready to close) CW.B0 = TRUE DC is ready
B02	Running	Drive not running (DCGuard open) The drive is not in run state (modulating)	Drive in run state / modulating (DCGuard open) The drive is in run state and modulating
B03	Fault	No active fault The drive is not in fault state	Fault is active The drive is in fault state
B04	Run enable status	Run Disabled Drive is in stop state (close disabled) DI: Run enable false	Run Enabled Drive can be started (close enabled)
B05	True ⁽¹⁾		
B06	CB control not OK ⁽¹⁾		
B07	Warning	No active warnings: There is no warning or the warning has disappeared.	Warning active: Drive still works, but there is a warning in the service/maintenance parameter. The warning has not been acknowledged.

Bit	Signal	False	True
B08	At reference ⁽¹⁾		
B09	Fieldbus control active	No control requested Control by the automation system is not possible.	Control requested The automation system is controlling.
B10	Above limit ⁽¹⁾		
B11	⁽²⁾		
B12	⁽²⁾		
B13	⁽²⁾		
B14			
B15	Watchdog ⁽³⁾	Fieldbus watchdog feedback low	Fieldbus watchdog feedback high

¹ Not used

² Reserved for future use

³ Fieldbus control word B11 is echoed back to the fieldbus. Can be used to monitor communication status from the drive.

6.12.4 Application Status Word

Table 57: Description of the Application Status Word (ID 43)

Bit	False	True
B00		
B01	Not in ready state DC voltage low, fault active	Ready Drive in ready state, start command can be given.
B02	Not running (open) Drive is not modulating	Running (closed) Drive is modulating
B03	No fault Drive has no active faults.	Fault Drive has active faults.
B04		
B05		
B06	Run disabled (close disabled) Run enable command to motor control is low.	Run enabled (close enabled) Run enable command to motor control is high.
B07	No warning No warning signals active in the drive.	Warning Drive has active warning signals. A warning signal does not stop the operation.
B08	Charging switch open DC voltage level has not reached the closing level or has dropped below the opening level. This information is from drive motor control.	Charging switch closed DC voltage level is above the closing limit and no interlock is active internally.
B09		

Bit	False	True
B10		
B11		
B12	No run request (no close request) Final run request command has not been given to motor control.	Run request (close request) Final run request command has been given to motor control.
B13		
B14	DCGuard open ⁽¹⁾	DCGuard closed ⁽¹⁾
B15		

¹ Not used

7 Fault Tracing

7.1 Troubleshooting Guidelines

In problem situations it is important to have proper information about the problem. If the problem persists, contact local Danfoss support. Before contacting support, follow the guidelines so that the necessary information for the problem solving is available.

- Install the newest available application and system software versions. The software is continuously developed and the default settings are improved.
- Use the fastest available communication speed (baud rate 57 600) and a 50 ms update interval for signals for the RS232 communication.
- For the CAN communication, use a 1 Mbit communication speed and 7 ms update interval for signals.
- When contacting Danfoss support because of a fault condition, always write down all texts and codes on the keypad display.
- When contacting Danfoss support, send the *.trn, *.par and Service info (*.txt) files with a description of the situation. If an active fault is causing the problem, take also the Datalogger data from the drive.
- The Datalogger settings can be changed to catch the correct situation and it is also possible to make a manual force trig for the Datalogger.
- Before storing the parameter file, upload the parameters from the drive and save them when VACON® NCDrive is in the ONLINE state. If possible, do this while the problem is active.
- It is also helpful to have a single-line diagram from the system in which problem is faced.

Type	Signal Name	Actual	Unit
Value	Status Word	20806	
Value	DC Voltage	592	Vdc
Value	DCG ControlState	7	
Value	DCG StatusWord	3	
Value	U Phase Current	0,1	A
Value	V Phase Current	0	A
Value	W Phase Current	0	A
Value	DC-Link Current	0,7	%

e30hg912.10

Illustration 25: Recommended Signals for VACON® NCDrive

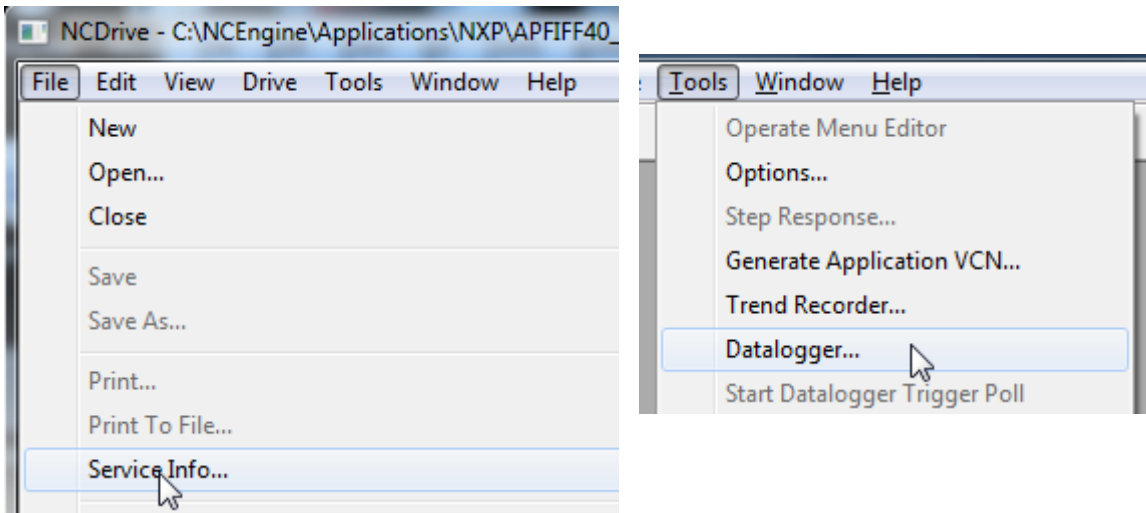

e30hg913.10

Illustration 26: Service Info Upload and Datalogger Window Opening

7.2 Faults and Alarms

7.2.1 Fault 1 - Overcurrent, S1- Hardware trip

Cause

There is too high a current (>4*I_N) in the motor cable. This has caused the VACON® NXP DCGuard™ instant current cut-off functionality to activate. Its cause can be 1 of the following:

- A sudden heavy load increase
- A short circuit in the motor cables

Troubleshooting

- Do a check of the loading.
- Do a check of the cables and connections.
- Make an identification run.

7.2.2 Fault 2 - Overvoltage, S1 - Hardware trip

Cause

The DC-link voltage is higher than the limits.

- 500 V AC unit DC voltage above 911 V DC
- 690 V AC unit DC voltage above 1200 V DC
- Too short a deceleration time
- High overvoltage spikes in the supply
- Start/Stop sequence too fast

Troubleshooting

- Set the deceleration time longer.
- Activate the overvoltage controller.
- Do a check of the input voltage.

7.2.3 Fault 2 - Overvoltage, S2 - Overvoltage control supervision

Cause

The DC-link voltage has been above 1100 V DC for too long.

- Too short a deceleration time
- High overvoltage spikes in the supply
- Start/Stop sequence too fast

Troubleshooting

- Set the deceleration time longer.
- Activate the overvoltage controller.
- Do a check of the input voltage.

7.2.4 Fault 3 - Earth fault

Cause

The measurement of current tells that the sum of the motor phase currents is not zero. The earth fault limit is set in parameter ID 1333.

- Insulation malfunction in the cables or in the motor.

Troubleshooting

Do a check of the motor cables.

7.2.5 Fault 5 - Charging switch

Cause

The charging switch is open, when the START command is given.

- Operation malfunction
- Defective component

Troubleshooting

- Check the connection of the feedback from the charging relay.
- Reset the fault and start the drive again.
- If the fault shows again, ask instructions from the local distributor.

7.2.6 Fault 7 - Saturation trip

Cause

- Defective component

Troubleshooting

This fault cannot be reset from the control panel.

- Switch off the power.
- DO NOT RESTART THE DRIVE or CONNECT THE POWER!
- If this fault shows at the same time with Fault 1, do a check of the motor cables.
- Contact your local distributor.

7.2.7 Fault 8 - System fault, S1 - Reserved

This fault code is reserved for future use.

Cause

- Disturbance.
- Driver board or IGBT is broken.
- In enclosure size FR9 and larger drives which include no star coupler, the ASIC board is broken.
- In enclosure size FR8 and smaller drives, the control board is broken.
- In enclosure size FR8 and smaller drives, the VACON Bus board is broken, if included in the drive.

Troubleshooting

- Reset the fault and start the drive again.
- If there is star coupler in the unit, check the fiber connections and phase order.

7.2.8 Fault 8 - System fault, S2 - Reserved

This fault code is reserved for future use.

7.2.9 Fault 8 - System fault, S3 - Reserved

This fault code is reserved for future use.

7.2.10 Fault 8 - System fault, S4 - Reserved

This fault code is reserved for future use.

7.2.11 Fault 8 - System fault, S5 - Reserved

This fault code is reserved for future use.

7.2.12 Fault 8 - System fault, S6 - Reserved

This fault code is reserved for future use.

7.2.13 Fault 8 - System fault, Subcode S7 - Charging switch

Cause

- operation malfunction
- defective component

Troubleshooting

- Reset the fault and start the drive again.
- If the fault shows again, ask instructions from the local distributor.

7.2.14 Fault 8 - System fault, Subcode S8 - No power to driver card

Cause

- operation malfunction
- defective component

Troubleshooting

- Reset the fault and start the drive again.
- If the fault shows again, ask instructions from the local distributor.

7.2.15 Fault 8 - System fault, Subcode S9 - Power unit communication (TX)

Cause

- operation malfunction
- defective component

Troubleshooting

- Reset the fault and start the drive again.
- If the fault shows again, ask instructions from the local distributor.

7.2.16 Fault 8 - System fault, Subcode S10 - Power unit communication (Trip)

Cause

- operation malfunction
- defective component

Troubleshooting

- Reset the fault and start the drive again.
- If the fault shows again, ask instructions from the local distributor.

7.2.17 Fault 8 - System fault, Subcode S11 - Power unit comm. (Measurement)

Cause

- operation malfunction
- defective component

Troubleshooting

- Reset the fault and start the drive again.
- If the fault shows again, ask instructions from the local distributor.

7.2.18 Fault 8 - System fault, Subcode S12 - System bus fault (slot D or E)

Cause

Error in system bus option board (OPTD1 or OPTD2) in slot D or E.

- operation malfunction
- defective component

Troubleshooting

- Reset the fault and start the drive again.
- If the fault shows again, ask instructions from the local distributor.
- Check the cables and connections.

7.2.19 Fault 8 - System fault, Subcode S30 - OPTAF: STO channels are different from each other

Cause

The Safe Disable inputs are in different states. It is not allowed according to EN954-1, category 3. This fault occurs when the Safe Disable inputs are in different states for more than 5 s.

Troubleshooting

- Check the S1 switch.
- Check the cabling to the OPTAF board.
- If the fault shows again, ask instructions from the local distributor.

7.2.20 Fault 8 - System fault, Subcode S31 - OPTAF: Thermistor short circuit detected

Cause

Thermistor short circuit detected.

Troubleshooting

- Correct the cable connections.
- Check the jumper for the thermistor short circuit supervision, if the thermistor function is not used and the thermistor input is short-circuited.

7.2.21 Fault 8 - System fault, Subcode S32 - OPTAF board has been removed

Cause

OPTAF board has been removed. It is not allowed to remove the OPTAF board once the software has recognized it.

Troubleshooting

The system requires a manual acknowledgement using *System* menu parameter 6.5.5 OPTAF Remove. Ask help from the local distributor.

7.2.22 Fault 8 - System fault, Subcode S33 - OPTAF: EEPROM error

Cause

OPTAF board EEPROM error (checksum, not answering and so on).

Troubleshooting

Change the OPTAF board.

7.2.23 Fault 9 - Undervoltage, Subcode S1 - DC-link too low during run

Cause

The DC-link voltage is lower than the limits.

- Too low a supply voltage
- AC drive internal fault
- A defective input fuse
- The external charge switch is not closed.

Troubleshooting

- If there is a temporary supply voltage break, reset the fault and start the drive again.
- Do a check of the supply voltage. If the supply voltage is sufficient, there is an internal fault.
- Check that the DC charging is functioning properly.
- Ask instructions from the local distributor.

7.2.24 Fault 9 - Undervoltage, Subcode S2 - No data from power unit

Cause

The DC-link voltage is lower than the limits.

- Too low a supply voltage
- AC drive internal fault
- a defective input fuse
- the external charge switch is not closed.

Troubleshooting

- If there is a temporary supply voltage break, reset the fault and start the drive again.
- Do a check of the supply voltage. If the supply voltage is sufficient, there is an internal fault.
- Check that the DC charging is functioning properly.
- Ask instructions from the local distributor.

7.2.25 Fault 9 - Undervoltage, Subcode S3 - Undervoltage control supervision

Cause

The DC-link voltage is lower than the limits.

- Too low a supply voltage
- AC drive internal fault
- A defective input fuse
- The external charge switch is not closed.

Troubleshooting

- If there is a temporary supply voltage break, reset the fault and start the drive again.
- Do a check of the supply voltage. If the supply voltage is sufficient, there is an internal fault.
- Ask instructions from the local distributor.

7.2.26 Fault 10 - Input line supervision, Subcode S1 - Phase supervision diode supply

Cause

The input line phase is missing.

Troubleshooting

Do a check of the supply voltage, the fuses, and supply cable.

7.2.27 Fault 10 - Input Line Supervision, S2 - Phase Supervision Active Front-End

Cause

Line sync fault. AFE is not able to synchronize to line after five trials.

Troubleshooting

- Check that input contactor closes.
- Check all fuses.
- Check that LCL filter is not broken.

7.2.28 Fault 11 - Line Phase Supervision

Cause

The measurement of current tells that there is no current in 1 motor phase or the current in 1 phase is considerably different from the other phases.

Troubleshooting

Do a check of the motor cables.

7.2.29 Fault 13 - AC drive undertemperature

Cause

Too low a temperature in the heat sink of the power unit or in the power board. The heat sink temperature is below -10 °C (14 °F).

Troubleshooting

Add an external heater near the AC drive.

7.2.30 Fault 14 - AC Drive Overtemperature

Cause

Overheating detected in the AC drive.

The heat sink temperature is over 90 °C (194 °F). An overtemperature alarm is issued when the heat sink temperature goes over 85 °C (185 °F).

In 525–690 V, FR6: Heat sink temperature is over 77 °C (170.6 °F). An overtemperature alarm is issued when the heat sink temperature goes over 72 °C (161.6 °F).

Troubleshooting

- Do a check of the actual amount and flow of cooling air.
- Examine the heat sink for dust.
- Do a check of the ambient temperature.
- Make sure that the switching frequency is not too high in relation to the ambient temperature and the motor load.

7.2.31 Fault 22 - EEPROM Checksum Fault

Cause

Parameter save fault.

- Operation malfunction
- defective component

Troubleshooting

If the fault occurs again, ask instructions from the local distributor.

7.2.32 Fault 24 - Counter fault

Cause

Values that showed on the counters are incorrect.

Troubleshooting

Have a critical attitude towards values shown on counters.

7.2.33 Fault 25 - Microprocessor Watchdog Fault

Cause

Start-up of the drive has been prevented. Run request is ON when new application is downloaded to the drive.

Troubleshooting

- Reset the fault and start the drive again.
- If the fault shows again, ask instructions from the local distributor.

7.2.34 Fault 26 - Start-up Prevented

Cause

Start-up of the drive has been prevented. Run request is ON when new application is downloaded to the drive.

Troubleshooting

- If it can be done safely, cancel the prevention of start-up.
- Remove Run request.

7.2.35 Fault 29 - Thermistor fault

Cause

The thermistor input of the option board has detected a too high motor temperature.

- Motor is overheated.
- Thermistor cable is broken.

Troubleshooting

- Do a check of the motor cooling and loading.
- Do a check of the thermistor connection.
- (If thermistor input of the option board is not in use it has to be short-circuited).

7.2.36 Fault 31 - IGBT temperature (hardware)

Cause

IGBT Inverter Bridge overtemperature protection has detected too high a short-term overload current.

Troubleshooting

- Check the load.
- Check the motor frame size.
- Make an identification run.

7.2.37 Fault 32 - Fan cooling

Cause

Cooling fan of the AC drive does not start, when ON command is given.

Troubleshooting

Ask instructions from the local distributor.

7.2.38 Fault 36 - Control unit

Cause

- The software needs newer version of the control unit.
- The control board version is incompatible with the software.
- The software version is incorrect.

Troubleshooting

- Change the control unit.
- Change the control board to the latest version.
- Check that the correct software is loaded to the control board.

7.2.39 Fault 37 - Device changed (same type), Subcode S1 - Control board

Cause

A new option board has replaced the old one in the same slot. The parameters are available in the drive.

Troubleshooting

Reset the fault. The device is ready for use. The drive starts to use the old parameter settings.

7.2.40 Fault 38 - Device added (same type), Subcode S1 - Control board

Cause

The option board was added. The same option board has been used in the same slot before. The parameters are available in the drive.

Troubleshooting

Reset the fault. The device is ready for use. The drive starts to use the old parameter settings.

7.2.41 Fault 39 - Device removed

Cause

An option board was removed from the slot.

Troubleshooting

The device is not available. Reset the fault.

7.2.42 Fault 40 - Device unknown, Subcode S1 - Unknown device

Cause

An unknown or mismatching device was connected (the power unit or option board).

Troubleshooting

Ask instructions from the local distributor.

7.2.43 Fault 40 - Device unknown, Subcode S2 - StarCoupler: power sub units are not identical

Cause

An unknown or mismatching device was connected (the power unit or option board).

Troubleshooting

Ask instructions from the local distributor.

7.2.44 Fault 41 - IGBT Temperature

Cause

IGBT Inverter Bridge overtemperature protection has detected too high a short-term overload current.

Troubleshooting

- Do a check of the loading.

7.2.45 Fault 44 - Device changed (different type), Subcode S1 - Control board

Cause

- Option board or power unit changed.
- New device of different type or different power rating.

Troubleshooting

- Reset.
- If option board was changed, set the option board parameters again.
- If power unit was changed, set AC drive parameters again.

7.2.46 Fault 45 - Device added (different type), Subcode S1 - Control board

Cause

Option board of different type added.

Troubleshooting

- Reset.
- Set the power unit parameters again.

7.2.47 Fault 50 - Analogue input $I_{in} < 4$ mA (sel. signal range 4 to 20 mA)

Cause

Current at the analog input is < 4 mA.

- Control cable is broken or loose
- signal source has failed.

Troubleshooting

Do a check of the current loop circuitry.

7.2.48 Fault 51 - External fault

Cause

Digital input fault.

Digital input has been programmed as external fault input and this input is active.

Troubleshooting

- Check the programming.
- Check the device which the error message indicates.
- Check the cabling for the respective device.

7.2.49 Fault 52 - Keypad communication fault

Cause

The connection between the control panel (or VACON® NCDriver) and the drive is defective.

Troubleshooting

Do a check of the control panel connection and the control panel cable.

7.2.50 Fault 53 - Fieldbus fault

Cause

The data connection between the fieldbus master and the fieldbus board is defective.

Troubleshooting

- Do a check of the installation and fieldbus master.
- If the installation is correct, ask instructions from the local distributor.

7.2.51 Fault 54 - Slot fault

Cause

Defective option board or slot.

Troubleshooting

- Do a check of the board and slot.
- Ask instructions from the local distributor.

7.2.52 Fault 56 - Measured Temperature

Cause

Shows temperature measurement fault for option board OPTBH or OPTB8.

- Temperature exceeded set limit.
- Sensor disconnected.
- Short circuit.

Troubleshooting

Find the cause of temperature rise.

7.2.53 Fault 59 - Follower communication

Cause

SystemBus or CAN communication is broken between Master and Follower.

Troubleshooting

- Do a check of the option board parameters.
- Do a check of the optical fiber cable or CAN cable.

7.2.54 Fault 60 - Cooling

Cause

External cooling has failed.

Normally this fault comes from the heat exchanger unit.

Troubleshooting

Do a check of the reason for the failure on the external system.

7.2.55 Fault 62 - Run disable

Cause

Run enable signal is low.

Troubleshooting

Do a check of the reason for the Run enable signal.

7.2.56 Fault 63 - U Phase Overcurrent

Cause

Phase U has experienced an overcurrent trip. The VACON® NXP DCGuard™ rapid current cut-off functionality activated the fault.

The current in phase U has exceeded the limit set with parameter *U phase trip limit* (ID 1500).

Troubleshooting

- Do a check of the loading.
- Do a check of the cables and connections.
- Make an identification run.

7.2.57 Fault 64 - V Phase Overcurrent

Cause

Phase V has experienced an overcurrent trip. The VACON® NXP DCGuard™ rapid current cut-off functionality activated the fault.

The current in phase V has exceeded the limit set with parameter *V phase trip limit* (ID 1501).

Troubleshooting

- Do a check of the loading.
- Do a check of the cables and connections.
- Make an identification run.

7.2.58 Fault 65 - W Phase Overcurrent

Cause

Phase W has experienced an overcurrent trip. The VACON® NXP DCGuard™ rapid current cut-off functionality activated the fault. The current in phase W has exceeded the limit set with parameter *W phase trip limit* (ID 1502).

Troubleshooting

- Do a check of the loading.
- Do a check of the cables and connections.
- Make an identification run.

7.2.59 Fault 66 - UV Phase Overcurrent

Cause

The VACON® NXP DCGuard™ peer-to-peer 2-cable system has experienced an overcurrent trip.

Troubleshooting

- Do a check of the loading.
- Do a check of the cables and connections.
- Make an identification run.

7.2.60 Fault 67 - F1 U Phase

Cause

Phase U has experienced an overcurrent trip.

Troubleshooting

- Do a check of the loading.
- Do a check of the cables and connections.
- Make an identification run.

7.2.61 Fault 68 - F1 V Phase

Cause

Phase V has experienced an overcurrent trip.

Troubleshooting

- Do a check of the loading.
- Do a check of the cables and connections.
- Make an identification run.

7.2.62 Fault 69 - F1 W Phase

Cause

Phase W has experienced an overcurrent trip.

Troubleshooting

- Do a check of the loading.
- Do a check of the cables and connections.
- Make an identification run.

7.2.63 Fault 70 - UVW Overcurrent

Cause

The VACON® NXP DCGuard™ peer-to-peer 3-cable system has experienced an overcurrent trip.

Troubleshooting

- Do a check of the loading.
- Do a check of the cables and connections.
- Make an identification run.

7.2.64 Fault 72 - License

Cause

VACON® NXP DCGuard™ operation is not activated.

Troubleshooting

- Set the license key with parameter ID 1995.

7.2.65 Fault 73 - VW Overcurrent

Cause

The VACON® NXP DCGuard™ peer-to-peer 2-cable system has experienced an overcurrent trip.

Troubleshooting

- Do a check of the loading.
- Do a check of the cables and connections.
- Make an identification run.

7.2.66 Fault 81 - External Fault 2

Cause

Digital input fault.

Digital input has been programmed as external fault 2 input and this input is active.

Troubleshooting

Remove fault situation on external device.

7.2.67 Fault 83 - U Phase Overload

Cause

Phase U has experienced an overload trip. The VACON® NXP DCGuard™ overload protection functionality activated the fault. The overload counter for phase U has reached the trip level. See [6.8.5.1 Function Description](#) for details.

Troubleshooting

- Do a check of the loading.
- Do a check of the cables and connections.
- Make an identification run.

7.2.68 Fault 84 - V Phase Overload

Cause

Phase V has experienced an overload trip. The VACON® NXP DCGuard™ overload protection functionality activated the fault. The overload counter for phase V has reached the trip level. See [6.8.5.1 Function Description](#) for details.

Troubleshooting

- Do a check of the loading.
- Do a check of the cables and connections.
- Make an identification run.

7.2.69 Fault 85 - W Phase Overload

Cause

Phase W has experienced an overload trip. The VACON® NXP DCGuard™ overload protection functionality activated the fault. The overload counter for phase W has reached the trip level. See [6.8.5.1 Function Description](#) for details.

Troubleshooting

- Do a check of the loading.
- Do a check of the cables and connections.
- Make an identification run.

7.2.70 Fault 86 - U High Current

Cause

Phase U has experienced a trip due to high current for a too long time. The VACON® NXP DCGuard™ high current cut-off functionality activated the fault.

The current in phase U has exceeded the limit set with parameter *U trip limit* (ID 1551) for the time set with parameter *U trip delay* (ID 1552).

Troubleshooting

- Do a check of the loading.
- Do a check of the cables and connections.
- Make an identification run.

7.2.71 Fault 87 - V High Current

Cause

Phase V has experienced a trip due to high current for a too long time. The VACON® NXP DCGuard™ high current cut-off functionality activated the fault.

The current in phase V has exceeded the limit set with parameter *V trip limit* (ID 1554) for the time set with parameter *V trip delay* (ID 1555).

Troubleshooting

- Do a check of the loading.
- Do a check of the cables and connections.
- Make an identification run.

7.2.72 Fault 88 - W High Current

Cause

Phase W has experienced a trip due to high current for a too long time. The VACON® NXP DCGuard™ high current cut-off functionality activated the fault.

The current in phase W has exceeded the limit set with parameter *W trip limit* (ID 1558) for the time set with parameter *W trip delay* (ID 1559).

Troubleshooting

- Do a check of the loading.
- Do a check of the cables and connections.
- Make an identification run.

7.2.73 Fault 89 - Software Overvoltage

Cause

The DC-link voltage is higher than the limit set with parameter *Vdc trip limit* (ID 1858).

- Too short a deceleration time
- High overvoltage spikes in the supply
- Start/Stop sequence too fast

Troubleshooting

- Set the deceleration time longer.
- Activate the overvoltage controller.
- Do a check of the input voltage.

Index

A

Additional resources.....	6
A11 Controlled ID (ID 1507).....	36
A11 Custom Setting Maximum (ID 322).....	35
A11 Custom Setting Minimum (ID 321).....	35
A11 Scale Maximum (ID 304).....	36
A11 Scale Minimum (ID 303).....	36
A11 Signal Filter Time (ID 324).....	35
A11 Signal Inversion (ID 387).....	35
A11 Signal Selection (ID 377).....	34
A12 Controlled ID (ID 1528).....	37
A12 Custom Setting Maximum (ID 327).....	37
A12 Custom Setting Minimum (ID 326).....	36
A12 Scale Maximum (ID 394).....	37
A12 Scale Minimum (ID 393).....	37
A12 Signal Filter Time (ID 329).....	36
A12 Signal Inversion (ID 398).....	37
A12 Signal Selection (ID 388).....	36
A13 Controlled ID (ID 1529).....	38
A13 Custom Setting Maximum (ID 145).....	37
A13 Custom Setting Minimum (ID 144).....	37
A13 Scale Maximum (ID 1038).....	38
A13 Scale Minimum (ID 1037).....	38
A13 Scale Minimum (ID 1039).....	39
A13 Signal Filter Time (ID 142).....	37
A13 Signal Inversion (ID 151).....	38
A13 Signal Selection (ID 141).....	37
A14 Controlled ID (ID 1530).....	39
A14 Custom Setting Maximum (ID 156).....	38
A14 Custom Setting Minimum (ID 155).....	38
A14 Scale Maximum (ID 1040).....	39
A14 Signal Filter Time (ID 153).....	38
A14 Signal Inversion (ID 162).....	39
A14 Signal Selection (ID 152).....	38
Alarm word 1 (ID 1174).....	30
Analog output 1 (ID 26).....	24
Analog output 1 filter time (ID 308).....	41
Analog output 1 function (ID 307).....	41
Analog output 1 inversion (ID 309).....	42
Analog output 1 minimum (ID 310).....	42
Analog output 1 offset (ID 375).....	43
Analog output 1 scale (ID 311).....	42
Analog output 1 signal selection (ID 464).....	41
Analog output 2 (ID 31).....	24
Analog output 2 filter time (ID 473).....	44
Analog output 2 function (ID 472).....	43
Analog output 2 inversion (ID 474).....	44
Analog output 2 minimum (ID 475).....	44
Analog output 2 offset (ID 477).....	44
Analog Output 2 Offset (ID 477).....	44
Analog Output 2 Scale (ID 476).....	44
Analog output 2 signal selection (ID 471).....	43
Analog output 3 (ID 32).....	24
Analog output 3 filter time (ID 480).....	44
Analog output 3 function (ID 479).....	44
Analog output 3 inversion (ID 481).....	45
Analog output 3 minimum (ID 482).....	45
Analog output 3 offset (ID 484).....	45
Analog output 3 scale (ID 483).....	45
Analog output 3 signal selection (ID 478).....	44
Analog outputs.....	41

C

Cabling (ID 1503).....	31
Compatibility.....	7
Control I/O.....	8
Control Input Signal ID (ID 1580).....	57
Control Mode (ID 1590).....	55
Control Off Limit (ID 1581).....	57
Control Off Value (ID 1583).....	57
Control On Limit (ID 1582).....	57
Control On Value (ID 1584).....	57
Control options 1 (ID 1084).....	47
Control options 2 (ID 1798).....	47
Control Output Signal ID (ID 1585).....	57
Control place (ID 125).....	60
Control Signal Filtering TC (ID 1721).....	57

D

Data logger trigger word (ID 97).....	28
DC voltage (ID 44).....	24
DC-link Amps (ID 3).....	23
DC-link current (ID 1861).....	23
DC-link power (ID 5).....	24
DC-link voltage (ID 1108).....	23
DCG control word (ID 1508).....	47
DCGuard closed (ID 445).....	40
DCGuard control status (ID 1870).....	27
DCGuard status word (ID 1869).....	27
Defining a terminal for a certain function.....	62
DIN Controlled ID (ID 1571).....	59
DIN Controlled ID (ID 1575).....	60
DIN Controlled ID (ID 1579).....	60
DIN status 1 (ID 56).....	26
DIN status 2 (ID 57).....	27
Disable stop lock (ID 1086).....	50

E

Earth fault current limit (ID 1333).....	51
Enable keypad close (ID 1863).....	61
Enable keypad open (ID 1864).....	61
Enable U (ID 1515).....	33
Enable V (ID 1516).....	33
Enable W (ID 1517).....	33
Expander boards.....	22
External fault 1 (ID 405).....	33
External fault 2 (ID 406).....	33

F

Fast reclosing (ID 1859).....	46
Fault (ID 434).....	40
Fault reset (ID 414).....	32
Fault simulation (ID 1569).....	50
Fault word 1 (ID 1172).....	29
Fieldbus actual selection (ID 1853).....	48
Fieldbus control.....	63
Fieldbus control (ID 411).....	34
Fieldbus control word (ID 1160).....	29, 63, 64
Fieldbus fault slot D response (ID 733).....	51
Fieldbus process data in 1 selection (ID 876).....	49
Fieldbus process data in 1 selection (ID 882).....	49
Fieldbus process data in 2 selection (ID 877).....	49

Fieldbus process data in 3 selection (ID 878).....	49	P	Power kW (ID 73).....	23
Fieldbus process data in 4 selection (ID 879).....	49		Prediction gain (ID 673).....	46
Fieldbus process data in 5 selection (ID 880).....	49		Pulse ratio (ID 606).....	46
Fieldbus process data in 6 selection (ID 881).....	49		Purpose of the manual.....	6
Fieldbus process data in 8 selection (ID 883).....	49			
Fieldbus process data out 1 selection (ID 852).....	48	R	Ready (ID 432).....	39
Fieldbus process data out 2 selection (ID 853).....	48		Requirements.....	7
Fieldbus process data out 3 selection (ID 854).....	48		Reset data logger (ID 1857).....	50
Fieldbus process data out 4 selection (ID 855).....	48		Reset U (ID 1518).....	33
Fieldbus process data out 5 selection (ID 856).....	48		Reset V (ID 1520).....	33
Fieldbus process data out 6 selection (ID 857).....	48		Reset W (ID 1519).....	33
Fieldbus process data out 7 selection (ID 858).....	48		Restart Delay (ID 1424).....	47
Fieldbus process data out 8 selection (ID 859).....	49		Run (ID 433).....	39
Fieldbus status word (ID 65).....	29		Run enable 1 (ID 407).....	32
Fieldbus status word (ID 68).....	65		Run enable 2 (ID 1860).....	32
Functional description.....	7			
		G		
General status word ID (ID 897).....	48		S	
			Software version.....	6
I			Start Delay (ID 1800).....	47
I/O configuration.....	8		Start signal 1 (ID 403).....	32
I/O terminal control (ID 409).....	33		Start signal 2 (ID 404).....	32
ID Control Digital Input (ID 1570).....	59		Start/Stop Logic Selection (ID 300).....	32
ID Control Digital Input (ID 1574).....	59		State machine (ID 896).....	50
ID Control Digital Input (ID 1578).....	60		Status word (ID 43).....	25, 66
INV commands (ID 1091).....	39		SW trip response (ID 1874).....	46
Inverted fault (ID 435).....	40		Switch lock (ID 1527).....	40
IU offset (ID 668).....	47		Switch lock current limit (ID 1862).....	45
			Switching frequency (ID 601).....	46
K			System integrator responsibilities.....	7
Keypad			System menu.....	21
Defining an input/output.....	61		T	
Defining unused inputs/outputs.....	63		Troubleshooting.....	68
Keypad control (ID 410).....	34		TTF programming.....	61
Keypad/PC fault mode (ID 1329).....	51			
		L		
Last active alarm (ID 74).....	29		U	
Last active fault (ID 37).....	29		U cable OK (ID 1509).....	40
License key (ID 1995).....	61		U high current response (ID 1550).....	54
			U high load (ID 1512).....	40
M			U over load response (ID 1524).....	52
Manual version.....	6		U phase current (ID 1851).....	24
Master/follower mode (ID 1324).....	48		U phase power (ID 1871).....	25
Maximum input U (ID 1505).....	52		U phase trip limit (ID 1500).....	45
Maximum input V (ID 1532).....	53		U trip delay (ID 1552).....	54
Maximum input W (ID 1535).....	53		U trip limit (ID 1551).....	54
Maximum step U (ID 1506).....	53		Unit temperature (ID 8).....	23
Maximum step V (ID 1533).....	53			
Maximum step W (ID 1536).....	54		V	
Minimum input U (ID 1504).....	52		V cable OK (ID 1510).....	40
Minimum input V (ID 1531).....	53		V high current response (ID 1553).....	54
Minimum input W (ID 1534).....	53		V high load (ID 1513).....	40
			V over load response (ID 1525).....	53
O			V phase current (ID 1852).....	25
Over load protection.....	51		V phase power (ID 1872).....	25
Overload U (ID 1521).....	33		V phase trip limit (ID 1501).....	45
Overload V (ID 1522).....	33		V trip delay (ID 1555).....	55
Overload W (ID 1523).....	33		V trip limit (ID 1554).....	54
			Value for High digital input (TRUE) (ID 1573).....	59

Value for High digital input (TRUE) (ID 1577).....	60	Warning (ID 436).....	40
Value for High digital input (TRUE) (ID 1588).....	60		
Value for Low digital input (FALSE) (ID 1572).....	59	X	
Value for Low digital input (FALSE) (ID 1576).....	60	X Value 01 (ID 1626).....	58
Value for Low digital input (FALSE) (ID 1587).....	60	X Value 02 (ID 1627).....	58
Vdc trip limit (ID 1858).....	51	X Value 03 (ID 1628).....	58
Voltage rise time (ID 1541).....	46	X Value 04 (ID 1629).....	58
		X Value 05 (ID 1630).....	58
W		X Value 06 (ID 1631).....	59
W cable OK (ID 1511).....	40		
W high current response (ID 1556).....	55	Y	
W high load (ID 1514).....	40	Y Value 01 (ID 2001).....	58
W over load response (ID 1526).....	53	Y Value 02 (ID 2002).....	58
W phase current (ID 1853).....	25	Y Value 03 (ID 2003).....	58
W phase power (ID 1873).....	25	Y Value 04 (ID 2004).....	58
W phase trip limit (ID 1502).....	46	Y Value 05 (ID 2005).....	59
W trip delay (ID 1559).....	55	Y Value 06 (ID 2006).....	59
W trip limit (ID 1558).....	55		

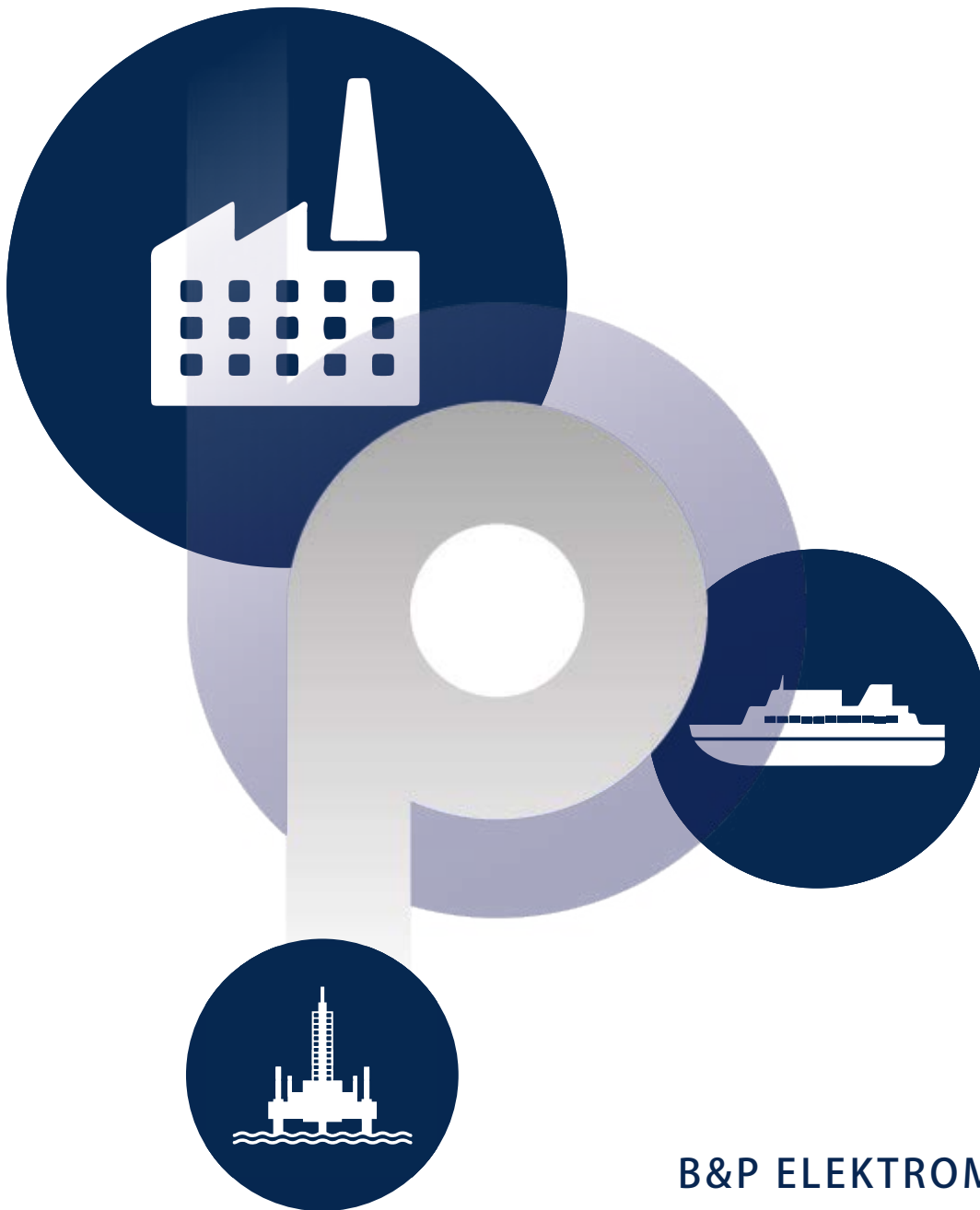

B&P ELEKTROMOTOREN BV

Ampèrestraat 8F
4004 KB Tiel

info@bnpelektromotoren.nl

+31 (0)344 616 267

BTW nr. NL819113918B01

KvK nr. 30237800

ING Bank NL60 INGB 0675 304 792



www.bnpelektromotoren.nl